

SOUTH DAKOTA DEPARTMENT OF TRANSPORTATION

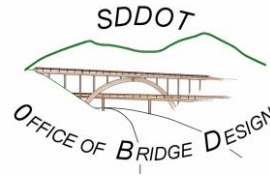

LOAD RATING MANUAL



July 2024 Edition

Prepared By:

**Office of Bridge Design, South Dakota Department of
Transportation with assistance from the Federal Highway
Administration**

The South Dakota Department of Transportation provides services without regard to race, color, gender, religion, national origin, age or disability, according to the provisions contained in SDCL 20-13, Title VI of the Civil Rights Act of 1964, the Rehabilitation Act of 1973, as amended, the Americans with Disabilities Act of 1990 and Executive Order 12898, Federal Actions to Address Environmental Justice in Minority Populations and Low-Income Populations, 1994. Any person who has questions concerning this policy or who believes he or she has been discriminated against should contact the Department's Civil Rights Office at 605-773-3540.

Table of Contents

CONTENTS	PAGE
SECTION 1 INTRODUCTION AND GENERAL OVERVIEW	4
1.1 USE OF THIS LOAD RATING MANUAL	4
1.2 DEFINITIONS, ABBREVIATIONS, AND ACRONYMS	4
1.2.1 Definitions and Terminology	4
1.2.2 Abbreviations and Acronyms	5
1.3 INTRODUCTION	5
1.4 PURPOSE OF THIS DOCUMENT	6
1.5 LOAD AND RESISTANCE FACTOR RATING METHODOLOGY	6
1.6 GENERAL LOAD RATING EQUATION	6
SECTION 2 GENERAL LOAD RATING REQUIREMENTS	7
2.1 LOAD RATING REQUIREMENTS	7
2.1.1 New or Reconstructed Bridges	7
2.1.2 Existing Bridges	7
2.2 QUALIFICATIONS AND RESPONSIBILITIES	8
2.3 ELEMENTS TO BE LOAD RATED	8
2.4 ANALYSIS AND TESTING METHODS IN LOAD RATING	9
2.5 ANALYSIS SOFTWARE	10
2.6 CONCRETE BRIDGES WITH UNKNOWN REINFORCEMENT	10
2.7 REPORTING LOAD RATINGS TO THE NBI	10
2.8 EVALUATION OF CONCRETE BRIDGES FOR SHEAR	10
2.9 STEEL SUPERSTRUCTURE BRIDGES WITHOUT PLANS	11
SECTION 3 LOAD AND RESISTANCE FACTOR RATING GUIDELINES	11
3.1 DATA COLLECTION FOR LRFR LOAD RATING	11
3.1.1 Review of Existing Bridge Plans and Documents	11
3.1.2 Bridge Inspection for Load Rating	11
3.1.3 Assessment of Truck Traffic Conditions at Bridge Site	11
3.1.4 Surface Roughness Dynamic Load Reduction	12
3.2 LOAD RATING, LIVE LOADS AND LOAD FACTORS	12
3.2.1 Overview of LRFR Load Rating Process for Bridges in South Dakota	12
3.2.2 Load Rating New Structures	13
3.2.3 Strength Rating for HL-93 Loading	14
3.2.4 Strength Rating for Legal Loads	15
3.2.5 Strength Rating for Specialized Hauling Vehicles	17
3.2.6 Strength Rating for Emergency Vehicles	19
3.2.7 Strength Rating for Overweight Permits	19
3.2.8 Reduced Dynamic Load Allowance for Load Rating (Legal & Permit Loads)	20
3.3 RESISTANCE FACTORS AND RESISTANCE MODIFIERS FOR THE STRENGTH LIMIT STATES	21
3.3.1 Resistance Factor: ϕ	21
3.3.2 Condition Factor: ϕ_C	21

3.3.3	System Factor: ϕ_s	22
3.4	RESISTANCE FACTORS AND RESISTANCE MODIFIERS FOR THE SERVICE LIMIT STATES	23
3.5	SERVICE & FATIGUE LIMIT STATES FOR LOAD RATING	23
3.5.1	General Overview	23
3.5.2	Concrete Bridges	23
3.5.3	Steel Bridges	24
SECTION 4	LRFR LOAD POSTING GUIDELINES	24
4.1	LOAD POSTING REQUIREMENTS FOR BRIDGES	24
4.2	RELIABILITY-BASED POSTING	24
4.3	POSTING ANALYSIS	25
SECTION 5	GENERAL LOAD POSTING GUIDELINES	25
5.1	LOAD POSTING REQUIREMENTS	25
5.2	POSTING ANALYSIS FOR EMERGENCY VEHICLES	25
5.3	POSTING SIGNS	26
5.3.1	Single Unit Vehicles	28
5.3.2	Combination Vehicles	29
5.4	ENTERING POSTINGS IN BrM	31
5.4.1	Item 41 – Structure Open, Posted, or Closed to Traffic	31
5.4.2	Item 70 –Posting	31
SECTION 6	LOAD RATING DELIVERABLES	32
6.1	LOAD RATING REPORTS	32
6.1.1	Load Rating Report Requirements for Consultants and Fabricators	32
6.1.2	Load Rating Documentation Required for Bridge Office Personnel	33
6.2	QUALITY CONTROL AND QUALITY ASSURANCE REVIEW OF LOAD RATINGS	33
6.3	QUALITY CONTROL OF LOAD POSTINGS	34
Appendix A:	LRFR Posting Example	35
Appendix B:	LFR Posting Example	37
Appendix C:	Sample Load Rating Summary Sheets	40
Appendix D:	Bridge Office Overload Procedures	42
Appendix E:	Overload Example 1	50
Appendix F:	Overload Example 2	53
REFERENCES:	56

SECTION 1 INTRODUCTION AND GENERAL OVERVIEW

1.1 USE OF THIS LOAD RATING MANUAL

This manual provides guidance to be considered when performing load rating of highway structures. This manual attempts to collect the practices and procedures of the South Dakota Department of Transportation (SDDOT) concerning load rating of highway structures, but it is intended to be used in conjunction with other guidance, specifications, manuals, policies, and information issued by SDDOT and AASHTO. Use of this manual is subject to sound engineering judgment and discretion.

1.2 DEFINITIONS, ABBREVIATIONS, AND ACRONYMS

1.2.1 Definitions and Terminology

- **Bridge** – (as defined in CFR 650.305) A structure including supports erected over a depression or an obstruction such as water, highways, or railway, and having a track or passageway for carrying traffic or other moving loads; and having an opening measured along the center of the roadway of more than 20 feet between undercopings of abutments, spring lines of arches, or extreme ends of opening for multiple boxes. It may also include multiple pipes, where the clear distance between openings is less than half of the smaller contiguous opening.
- **Combination Vehicle** – A vehicle with a power unit and separable trailer or body.
- **In-place Fill Height** - The installed depth of material over a culvert in a driving lane measured between the top of the driving surface and the top of the culvert below. For rating purposes use the maximum installed fill height to the nearest 3”.
- **Live Load Distribution Factor** – The fraction of a rating truck or lane load assumed to be carried by a structural component. The AASHTO Standard Specifications for Highway Bridges uses wheel line distribution factors whereas the AASHTO LRFD Bridge Design Specifications uses axles.
- **Load Rating** – The determination of the live-load carrying capacity of an existing bridge.
- **Load Factor** – A load multiplier accounting for the variability of loads, the lack of accuracy in analysis, and the probability of simultaneous occurrence of different loads.
- **Program Manager** – The individual in charge of the program that has been assigned or delegated the duties and responsibilities for bridge inspection, reporting, and inventory. The program manager provides overall leadership and is available to inspection team leaders to provide guidance.
- **Single Unit Vehicle** – a vehicle that the power unit and truck body are permanently attached and can't be easily separated, regardless of number of tires, axles, etc.

1.2.2 Abbreviations and Acronyms

AASHTO - American Association of State Highway and Transportation Officials

ADT – Average Daily Traffic

ADTT – Average Daily Truck Traffic

ASD – Allowable Stress Design

ASR – Allowable Stress Rating

BrD – AASHTOWare Bridge Design

BrDR – AASHTOWare Bridge Design and Rating

BrM – AASHTOWare Bridge Management

BrR – AASHTOWare Bridge Rating

CFR – Code of Federal Regulations

DF – Distribution Factor (for live load)

EV – Emergency Vehicle

FCM – Fracture Critical Member

FHWA – Federal Highway Administration

LFD – Load Factor Design

LFR – Load Factor Rating

LL – Live Load

LRFD – Load and Resistance Factor Design

LRFR – Load and Resistance Factor Rating

MBE – AASHTO Manual for Bridge Evaluation

MPH – Miles Per Hour

NBI – National Bridge Inventory

NBIS – National Bridge Inspection Standards

NSG – Non-Standard Gage

QA – Quality Assurance

QC – Quality Control

RF – Rating Factor

SDAPS – South Dakota Automated Permitting System

SDDOT – South Dakota Department of Transportation

SI&A – Structure Inventory and Appraisal

1.3 INTRODUCTION

Bridge load rating is the determination of the live load carrying capacity of a newly designed or existing bridge. Load ratings are typically determined by analytical methods based on information taken from bridge plans and supplemented by information gathered from field inspections or field testing. Knowledge of the capacity of each bridge to carry loads is critical for several reasons, including (but not limited to) the following:

- Safety to the traveling public.
- To determine which structures have substandard load capacities that may require posting or other remedial action.
- To assist in the most effective use of available resources for rehabilitation or replacement.
- To assist in the overload permit review process.

FHWA requires an annual submittal of bridge load ratings. The NBIS (Title 23, Code of Federal Regulations, Section 650.313(c)) <https://www.law.cornell.edu/cfr/text/23/650.313>, requires that load ratings are in accordance with the latest AASHTO Manual.

1.4 PURPOSE OF THIS DOCUMENT

This document was developed using the 3rd Edition of the American Association of State Highway Officials (AASHTO) *Manual for Bridge Evaluation*, hereinafter referred to as the MBE. This document provides guidance to load rating engineers for performing and submitting load rating calculations and posting bridges for load restrictions. The procedures stated in this document are to provide guidelines that will result in consistent and reproducible load rating inputs and deliverables. This document serves as a supplement to the AASHTO MBE and deals primarily with SDDOT specific load rating requirements, interpretations, and policy decisions. This document focuses primarily on Load and Resistance Factor Rating (LRFR) as SDDOT realizes the use of LRFR will continue to expand because LRFR gives consistently reliable load ratings. SDDOT currently uses Load Factor Rating (LFR) for load rating on many existing bridges and most overweight permitting.

1.5 LOAD AND RESISTANCE FACTOR RATING METHODOLOGY

Load and Resistance Factor Rating is consistent with the Load and Resistance Factor Design (LRFD) Specifications in using a reliability-based limit states philosophy and extends the provisions of the LRFD Specifications to the areas of inspection, load rating, posting and permit rules, fatigue evaluation, and load testing of existing bridges. The LRFR methodology has been developed to provide uniform reliability in bridge load ratings, load postings and permit decisions. The LRFR procedures provide live load factors for load rating that have been calibrated to provide a uniform and acceptable level of reliability.

1.6 GENERAL LOAD RATING EQUATION

The general load rating equation in LRFR (MBE Eq. 6A.4.2.1-1) is given as:

$$RF = \frac{\phi_c \phi_s \phi R_n - (\gamma_{DC})(DC) - (\gamma_{DW})(DW) \pm (\gamma_P)(P)}{(\gamma_L)(LL + IM)}$$

In the LRFR Rating Factor equation:

- RF = Rating Factor
- R_n = Nominal member resistance (as inspected)
- φ_c = Condition Factor (See Section 3.3)
- φ_s = System Factor (See Section 3.3)
- φ = LRFD Resistance Factor
- DC = Dead load effect due to structural components and attachments
- DW = Dead load effect due to wearing surface and utilities
- P = Permanent loads other than dead loads (secondary prestressing effects, etc.)
- LL = Live load effect of the rating vehicle
- IM = Dynamic load allowance (See Section 3.2)
- γ_{DC} = LRFD load factor for structural components and attachments
- γ_{DW} = LRFD load factor for wearing surfaces and utilities
- γ_P = LRFD load factor for permanent loads other than dead loads

γ_L = Evaluation live load factor for the rating vehicle (See Section 3.2)

The load and resistance factors for evaluation are as provided in MBE Section 6 and Sections 3.2 and 3.3 in this document.

SECTION 2 GENERAL LOAD RATING REQUIREMENTS

2.1 LOAD RATING REQUIREMENTS

South Dakota requires design plans for all new structures. Some effort may be needed to find design, as-built, or shop plans that may be needed to perform a load rating for existing structures.

2.1.1 New or Reconstructed Bridges

Load ratings by the LRFR method, for the live load vehicles defined in Section 3.2 of this document, are required for all new and replacement bridges, and for all rehabilitation and repair designs involving a substantial structural alteration. The FHWA 2006 load rating memorandum provides an exception in that allowable stress ratings are permissible for new timber structures. Load rating calculations will be performed as part of the design process and reflect the bridge as-built or as-rehabilitated. Don't include future wearing surface dead load when load rating new or reconstructed bridges because the load is not part of the as-built condition. For all new, replaced, and rehabilitated bridge projects, load ratings are required to be performed in conjunction with the preparation of design or shop plans and the load rating results submitted in the format described in Section 5 of this document. As-built plans should note any deviations from design plans and the load rating will be updated as required.

2.1.2 Existing Bridges

After each inspection determine if re-analysis is required. An updated load rating would usually be necessary if any of the following have occurred since the last load rating was completed:

- The primary member condition rating has changed.
- Dead load has changed due to resurfacing or other non-structural alterations such as utilities.
- Section properties have changed due to deterioration, rehabilitation, re-decking, or other alterations.
- Damage due to vessel or vehicular hits.
- Cracking in primary members.
- Losses at critical connections.
- Significant changes in traffic loadings, traffic volume.
- Specification changes.
- Issuance of overweight permits.
- Bridge is under construction.
- Soil and substructure settlement and slope stability.

All existing bridges that have not been load rated previously will be load rated at the time of the next inspection in accordance with the requirements of this document and the MBE. Bridges built before 2010 that weren't designed LRFD may still be rated using LFR. Much of the guidance contained in this document involves LRFR and references Section 6, Part A of the MBE. Additional guidance for Allowable Stress Rating (ASR) and Load Factor Rating (LFR) can be found in MBE Section 6, Part B. Allowable stress ratings are only permissible on timber or masonry structures.

2.2 QUALIFICATIONS AND RESPONSIBILITIES

The engineering expertise necessary to properly evaluate a bridge varies widely with the complexity of the bridge. Evaluation in accordance with this Manual will be performed and checked by suitably qualified engineers in the type of bridges being load rated. It is expected that load rating engineers using LRFR will have a working knowledge of the LRFD Specifications. SDDOT requires all consultant load ratings and rating checks to be dated, signed, and sealed by licensed professional engineers.

2.3 ELEMENTS TO BE LOAD RATED

Load rating will include analysis of the following items:

- All elements defined as “primary members.”
- Capacity of gusset plates and connection elements for non-redundant steel truss bridges
- Other connections of non-redundant systems.
- Timber and metal bridge decks.
- Metal and timber pier and bent caps.
 - All metal and timber pier and bent caps must be load rated.

Slab on Girder Bridges

- It is not necessary to analyze concrete bridge decks on stringers provided the decks do not affect the load carrying capacity of the entire bridge.
- Any ratings on new bridges or new ratings on existing bridges should be based on girder-system models. Girder-line models with both interior and exterior girders modeled are satisfactory for existing bridges until a re-rating is required.

Slab Bridges

When load rating slab bridges in BrR both interior slab strips and edge beams are required to be analyzed.

Culverts

- Provide load ratings, load rating summaries, and BrM load ratings at the in-place fill height.
- In-place fill height is the maximum installed fill height in a driving lane to the nearest 3”.

FHWA Technical Advisory T5140.29 <https://www.fhwa.dot.gov/bridge/t514029.cfm>, dated January 15, 2008, recommends that during future recalculations of load capacity on existing non-redundant load path steel bridges, the capacity of gusset plates be checked to reflect changes in condition or dead load, to make permit or posting decisions, or to account for structural modifications or other alterations that result in significant changes in stress levels. Previous load ratings should also be reviewed for bridges which have been subjected to significant changes in stress levels, either temporary or permanent, to ensure that the capacities of gusset plates were

adequately considered. Gusset plates and connection elements of existing non-load path redundant steel bridges that have not undergone a load capacity evaluation in the past will be checked for compliance with Technical Advisory T5140.29.

2.4 ANALYSIS AND TESTING METHODS IN LOAD RATING

Routine load ratings consist of computations made from design plans, as-built drawings, field measurements, and inspection reports based on common analytical methods, such as LRFD distribution analysis. The load rater should review the original design plans as the first source of information for material strengths and stresses. If the material strengths are not explicitly stated on the design plans, SDDOT material specifications applicable at the time of the bridge construction will be reviewed. This may require investigations into the ASTM or AASHTO Material Specifications in effect at the time of construction. Section 6 of the MBE and SDDOT's estimated material strengths shown below in Table 1 also provide guidance on material strengths to allow the evaluation of existing bridges with unknown material properties.

Material	Year of Construction	fy (ksi)
Structural Steel	Before 1905	26
	1905 - 1935	30
	1936 - 1962	33
	1963 - 1994	36
	1995 - present	50
Reinforcing Steel	Before 1945	33
	1945 - 1969	40
	1970 - present	60

Material	Year of Construction	f'c (ksi)
Cast-in-place Concrete	Before 1948	3.0
	1948 - 1969	4.0
	1970 - present	4.5

Table 1 - Estimated Material Strengths by Year of Construction – South Dakota Structures

Structures rated by field evaluation/engineering judgement must have load rating values entered on the load rating summary sheet and in BrM for the design vehicles, SD Type 3 vehicles, and SHV's. If the structure is within 1 mile of interstate access, enter EV ratings also. Contact the Office of Bridge Design for assistance in assigning EV ratings when structures are rated by field evaluation/engineering judgement. Include documentation or narrative explaining how any field evaluation load ratings were determined.

All new bridges are required to be rated with LRFD load distribution factors (see exception for timber bridges in Section 2.1.1). Refined analysis will only be accepted with the express written consent of SDDOT and should not be undertaken without the prior approval of the SDDOT Bridge Management Engineer.

Higher level load ratings may consist of routine computations adjusted for actual material properties as determined from field sampling and tests of the materials. Higher level load ratings may also require the use of refined methods of analysis such as 2-D grillage or 3-D finite element models.

Refined methods of analysis are justified where needed to avoid load posting or to ease restrictions on the flow of permitted overweight trucks. Load rating some of the more complex structure types (segmental bridges, curved-girders, cable-stayed, etc.) may require a more sophisticated level of analysis.

The actual performance of most bridges is more favorable than conventional theory dictates. If directed by SDDOT, the safe load capacity for a structure can be determined from full scale non-destructive field load tests, which may be desirable to establish a higher safe load carrying capacity than calculated by analysis. Refer to the MBE Section 8 for information on conducting field load tests and using the results to establish a new or updated load rating. This method of load rating will only be accepted with the express written consent of SDDOT. No investigations of this nature should be undertaken without the prior approval of the SDDOT Chief Bridge Engineer.

2.5 ANALYSIS SOFTWARE

Applying standard analysis tools to South Dakota's bridge inventory can maximize efficiency, provide consistency, and facilitate future revisions of load ratings by different parties. To this end SDDOT has specified AASHTOWare Bridge Rating (BrR) as the acceptable load rating software. If a bridge is capable of being defined within the parameters of the BrR software, it must be rated using BrR. Use of other analysis software for load rating requires the written consent of SDDOT.

2.6 CONCRETE BRIDGES WITH UNKNOWN REINFORCEMENT

For bridges where necessary details, such as reinforcement in a concrete bridge, are not available from plans or field measurements, knowledge of the live load used in the original design, the current condition of the structure and live load history may be used to provide a basis for assigning a safe load capacity. A concrete bridge or concrete bridge length culvert with unknown details need not be posted for restricted loading if it has been carrying normal traffic for an appreciable period and shows no distress (MBE 6.1.4). The bridge office considers "an appreciable period" to be at least 10 years. Nondestructive field load tests can be helpful in establishing the safe load capacity for such structures.

2.7 REPORTING LOAD RATINGS TO THE NBI

The NBI submittal requires inventory and operating ratings for the design load. The Inventory rating (Item 66) should be lower than the Operating rating (Item 64). In the case of concrete bridges without plans where load ratings can't be calculated, SDDOT suggests using a factor of 3/5 applied to the operating rating to get the inventory rating. If it is known that the structure was originally designed ASD or LRFD, a factor of 1/1.3 may be permissible. **Note that a bridge must be closed if the value entered for either item 64 or item 66 is below 3 tons.**

2.8 EVALUATION OF CONCRETE BRIDGES FOR SHEAR

MBE Article 6A.5.8 states that in-service concrete bridges that show no visible signs of shear distress need not be checked for shear when load rating for the design load or legal loads. SDDOT requires that all existing reinforced and prestressed concrete bridge members, except for concrete slab bridges, be evaluated for shear for all design and legal loads - including EV's when appropriate.

2.9 STEEL SUPERSTRUCTURE BRIDGES WITHOUT PLANS

As part of a thorough field investigation, dimensions of bridge components will be measured, sketches developed, conditions assigned, material strengths determined, and a load rating performed.

SECTION 3 LOAD AND RESISTANCE FACTOR RATING GUIDELINES

3.1 DATA COLLECTION FOR LRFR LOAD RATING

3.1.1 Review of Existing Bridge Plans and Documents

As-built plans are contract design plans which have been modified to reflect changes made during construction. As-built plans are used to determine loads, bridge geometry, section, and material properties. Shop drawings are also useful sources of information about the bridge. Complete field measurements will be required when plans do not exist for a bridge. Certain structures or components of structures are built from standard drawings. These standard drawings may have been changed and revised over time. Other appropriate bridge history records, testing reports, repair or rehabilitation plans should be reviewed to determine their impact on the load carrying capacity of the structure.

3.1.2 Bridge Inspection for Load Rating

Bridges being investigated for load capacity must be inspected for condition as per the latest edition of the SDDOT Bridge Inspection Field Manual, the MBE and the FHWA Bridge Inspector's Reference Manual. Bridge inspections are conducted to determine the physical and functional condition of the bridge; to form the basis for the evaluation and load rating of the bridge, as well as analysis of overload permit applications. The inspector should verify the accuracy of existing plans or sketches in lieu of plans with field measurements. It is especially important to measure and document items that may affect the load capacity, such as dead loads and section deterioration and damage. Only sound material should be considered in determining the nominal resistance of the deteriorated section. Where present, utilities, attachments, depth of fill, and thickness of wearing surface should be field verified at the time of inspection. Wearing surface thicknesses are also highly variable. Multiple measurements at curbs and roadway centerline should be used to determine an average wearing surface thickness. The LRFD/LRFR load factor for DW at the strength limit state may be taken as 1.25 where thickness has been measured in the field.

3.1.3 Assessment of Truck Traffic Conditions at Bridge Site

LRFR live load factors appropriate for use with legal loads and permit loads are defined based upon the ADTT available or estimated for the bridge site. FHWA requires an ADTT to be recorded on the Structural Inventory and Appraisal (SI&A) form for all bridges. ADTT may also be estimated from ADT data for the site.

3.1.4 Surface Roughness Dynamic Load Reduction

The LRFD dynamic load allowance of 33% reflects conservative conditions that may prevail under certain distressed approach and bridge deck conditions. For load rating of legal and permit vehicles for bridges with less severe approach and deck surface conditions, the dynamic load allowance (IM) may be decreased based on field observations in accordance with MBE Table C6A.4.4.3-1 (see Section 3.2.8). Inspectors should carefully note these and other surface discontinuities to benefit from a reduced dynamic load allowance. Do not apply any reductions if the most recent inspection doesn't specifically note approach and deck surface roughness.

3.2 LOAD RATING, LIVE LOADS AND LOAD FACTORS

3.2.1 Overview of LRFR Load Rating Process for Bridges in South Dakota

Live loads to be used in the load rating of bridges are selected based upon the purpose and intended use of the load rating results. Live load models outlined below will be evaluated for the Strength, Service and Fatigue limit states in accordance with Table 3:

- 1) Design load rating is a first-level rating performed for all bridges using the HL-93 loading at the Inventory (Design) and Operating levels.
- 2) Rate for the state legal loads: SD Type 3, SD Type 3S2 and SD Type 3-2, given in Figure 1. Legal lane loads given in Figure 2 are to be used for spans greater than 200 ft and for negative moment areas.
- 3) Rate for the NRL and SHV loads given in Figures 3 and 4.
- 4) Rate for the EV loading shown in Figure 5

Bridge Type	Limit State	Design	Legal	SHV/EV
		HL-93	SD Type 3, SD Type 3S2, SD Type 3-2	NRL, SU4, SU5, SU6, SU7, EV2, EV3
Steel	Strength I	•	•	•
	Service II	•	•	•
	Fatigue	•		
Reinforced Concrete	Strength I	•	•	•
Prestressed Concrete (non-segmental)	Strength I	•	•	•
	Service III	•	•	
Timber	Strength I	•	•	•

Table 3 LRFR Limit States

For bridges, the main superstructure support system will be completely described using schedule-based input in BrDR (BrR). Girder bridges must be defined as a system of girders, not as single structural elements (line girder analysis). Slab bridge models must

include edge beams. The most up to date design data will be used for load rating the selected alternative bridge superstructure or box culvert, if applicable.

Bridge alternative(s) must be defined and appropriately marked to allow for the load rating to be run from the Bridge Explorer window. After each significant change in condition, collision incident and/or construction event (including As-Built conditions, maintenance/rehabilitation activities, etc.) a new bridge alternative shall be developed and the structure re-rated.

Load ratings will be done using the Load and Resistance Factor Rating method (LRFR). This will include a rating for the HL-93 design loading at both the Inventory and Operating levels. Designers will provide load capacity analysis calculations in accordance with the current edition of the AASHTO “Manual for Bridge Evaluation” with the latest interim revisions.

3.2.2 Load Rating New Structures

As part of the design process for new bridges and cast-in-place box culverts, the designer will perform a load rating analysis and the check designer will perform a load rating check. The load rating should be conducted after the bridge superstructure or box culvert design check process is complete and prior to initial plans preparation. Precast box culverts or other precast superstructure elements will be rated by the Fabricator and this requirement will be noted in the construction plans. Load ratings for precast boxes or other precast superstructure elements will be submitted with the shop drawings.

For each new superstructure or cast-in-place box culvert subject to review by the bridge office attach an AASHTOWare BrR load rating summary to the 90% complete structure review plans.

State-owned structures: All sections of the main supporting superstructure members, or culvert, will load rate at 1.0 or better for HL-93 loading at the inventory level. The three SD Legal Loads, the four specialized hauling vehicles, and both EV’s will rate 1.0 or greater at the legal load rating level.

Locally owned structures (excluding concrete box culverts): All sections of the main supporting superstructure members, or culvert, will load rate at 1.0 or better for HL-93 loading at the inventory level. The three SD Legal Loads, the four specialized hauling vehicles, and both EV’s will rate 1.0 or greater at the legal load rating level.

Locally owned concrete box culverts: All sections of the concrete box culvert will load rate at 1.0 or better for HL-93 loading (Inventory Level). The three SD Legal Loads, and the four specialized hauling vehicles will rate 1.0 or greater at the legal load rating level. Box culverts located within a mile of interstate access must rate 1.0 or better for the two Emergency Vehicles at the legal load level. Concrete box culverts located more than 1 mile from interstate access must have emergency vehicle ratings of 0.8 or greater.

Table 2 below displays the minimum rating factor allowed for new structures for various combinations of structure types, owners, and locations.

Bridge Owner	Structure Type & Location	Inventory	Operating	Legal	Legal	Legal
		HL-93	HL-93	SD Type 3, SD Type 3S2, SD Type 3-2	NRL, SU4, SU5, SU6, SU7	EV2, EV3
State of South Dakota	All types in all Locations	1.0	1.0	1.0	1.0	1.0
City, County, Township, etc.	Concrete Box Culverts within 1 mile of Interstate access	1.0	1.0	1.0	1.0	1.0
	Concrete Box Culverts more than 1 mile from Interstate access	1.0	1.0	1.0	1.0	0.8
	All other Structures in all Locations	1.0	1.0	1.0	1.0	1.0

Table 2 – Minimum Required Load Ratings for New Structures

3.2.3 Strength Rating for HL-93 Loading

The design-load rating (or HL-93 rating) assesses the performance of existing bridges utilizing the LRFD HL-93 design loading and design standards with dimensions and properties for the bridge in its present as-inspected condition. It is a measure of the performance of existing bridges to new bridge design standards contained in the LRFD Specifications. The design-load rating produces Inventory and Operating level rating factors for the HL-93 loading. The evaluation live-load factors for the Strength I limit state will be taken as given in MBE Table MBE 6A.4.3.2.2-1.

Evaluation Level	Load Factor
Inventory	1.75
Operating	1.35

Table MBE 6A.4.3.2.2-1 Load Factors for Design Load: γ_L

The dynamic load allowance specified in the LRFD Specifications for new bridge design (LRFD Article 3.6.2) applies. For design load rating, regardless of the riding surface condition or the span length, always use 33% for the dynamic load allowance (IM).

The results of the HL-93 rating are entered in BrM and reported to the NBI.

3.2.4 Strength Rating for Legal Loads

Load rating for legal loads determines a single safe load capacity of a bridge. All legal load rating vehicles have a 6'-0" gage width.

Posting bridges for single unit vehicles will be accomplished by rating the SD Type3, SU4, SU5, SU6, and SU7 vehicles. Use the SD Type 3S2 and SD Type 3-2 live loads to determine posting for combination vehicles. These trucks are sufficiently representative of routine commercial truck configurations in use in South Dakota and are used as vehicle models for load rating and bridge posting purposes.

It is unnecessary to place more than one vehicle in a lane or include the lane-type legal load model from the MBE for spans up to 200 ft. because the LRFR live load factors provided have been modeled for this possibility. For negative moments and for span lengths greater than 200 feet, critical load effects will be obtained by lane-type legal load models shown in Figure 2.

The 2013 MBE interims changed the load factors for load rating reinforced concrete box culverts for the strength limit state for legal loads to 2.0 (See MBE Table 6A.5.12.5-1). For all other structure types, the live-load factors for AASHTO and SDDOT legal loads for the Strength I limit state will be taken as given in Table MBE 6A.4.4.2.3a-1.

Traffic Volume (One direction)	Load Factor
Unknown	1.45
ADTT \geq 5000	1.45
ADTT \leq 1000	1.30

Linear interpolation is permitted for ADTT values between 1000 and 5000

Table MBE 6A.4.4.2.3a-1 Live-Load Factors, γ_L for Routine Commercial Traffic

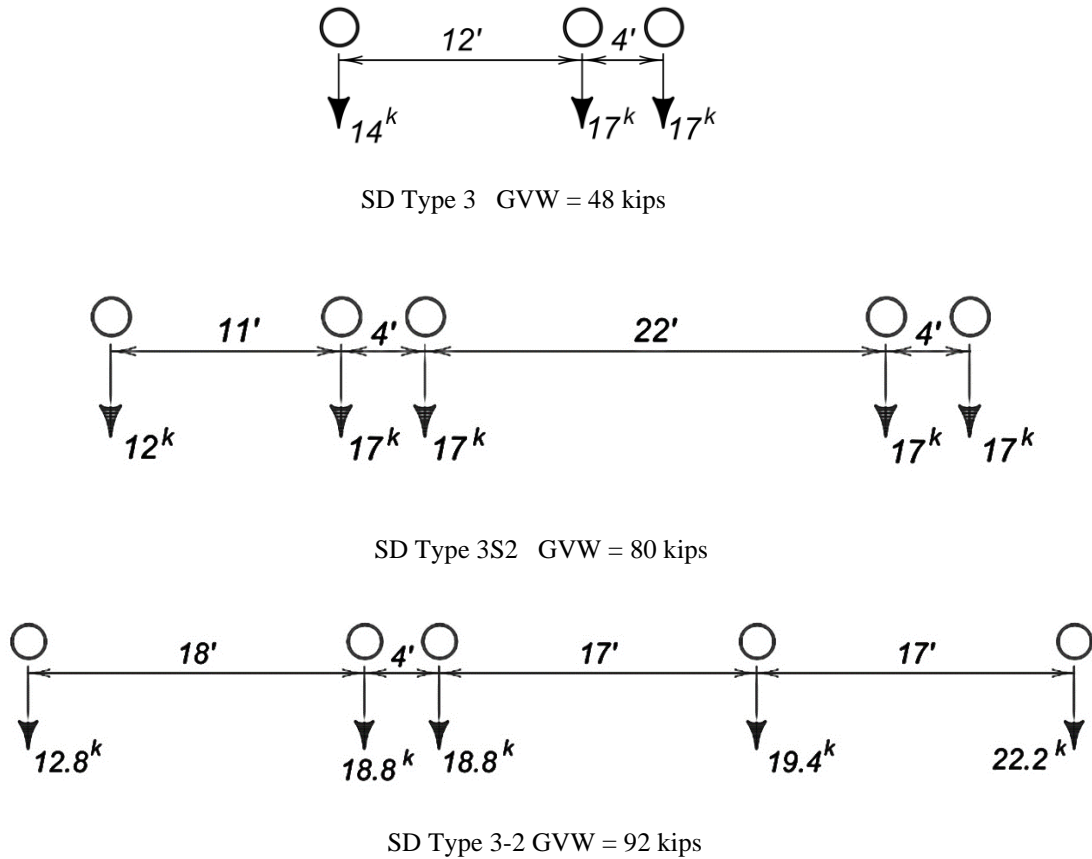
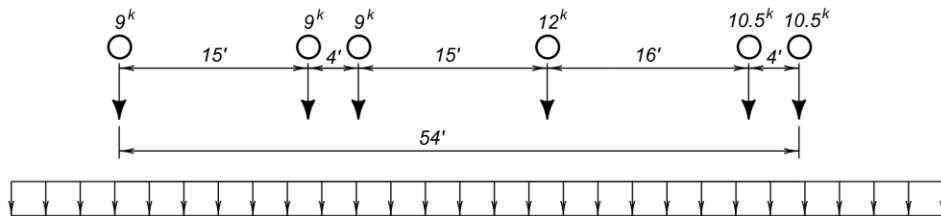

Figure 1. Load Rating Trucks for South Dakota Legal Loads

Lane-Type Legal Load Model—Apply for spans greater than 200 ft. and all load effects.

Concentrated Loads are axle loads (75% of AASHTO Type 3-3)
Legal Lane Weight = 0.2 k/ft.



Lane-Type Legal Load Model—Apply for negative moment and interior reaction for all span lengths.

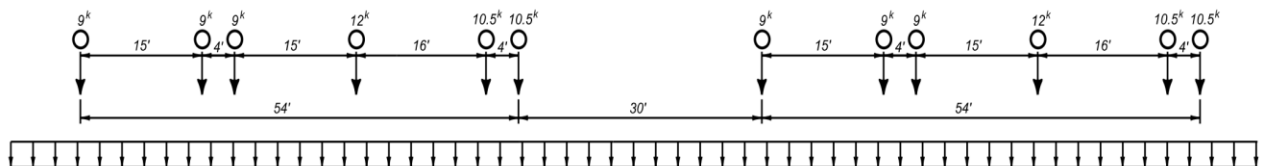

Figure 2. LRFR Legal Lane Load Models (MBE APPENDIX D6A)

3.2.5 Strength Rating for Specialized Hauling Vehicles

In recent years, the trucking industry has introduced single unit Specialized Hauling Vehicles (SHV) with closely spaced multiple axles that make it possible for these short wheelbase trucks to carry the maximum load of up to 80,000 pounds and still meet Federal Bridge Formula B and axle weight limit requirements. Because of the higher load effects of these vehicles, especially on short span bridges, AASHTO adopted a new live load rating model and four new single unit trucks as legal loads for bridge posting. The four single unit posting trucks SU4, SU5, SU6 and SU7 shown in Figure 4, model the short wheelbase multi-axle SHVs that are becoming increasingly more common in South Dakota.

The Notional Rating Load (NRL) shown in Figure 3, represents a single load model for load rating that will envelop the load effects of the worst possible SHV configurations with multiple axles on simple and continuous span bridges. Submit NRL load rating for all structures even though posting for single unit vehicles will be determined using the AASHTO single unit posting loads SU4, SU5, SU6, and SU7 plus the SD Type 3 truck. LRFD distribution factors are used for the distribution analysis.

The 2013 MBE interims changed the load factors for load rating reinforced concrete box culverts at the strength limit state for legal loads to 2.0 (See MBE Table 6A.5.12.5-1). For all other structure types use the live-load factors given in Table MBE 6A.4.4.2.3b-1 for NRL and SHV loads at the Strength I limit state.

Traffic Volume (One direction)	Load Factor
Unknown	1.45
ADTT \geq 5000	1.45
ADTT = 1000	1.30

Linear interpolation is permitted for ADTT values between 1000 and 5000

Table MBE 6A.4.4.2.3b-1 Live-Load Factors, γ_L for Specialized Hauling Vehicles

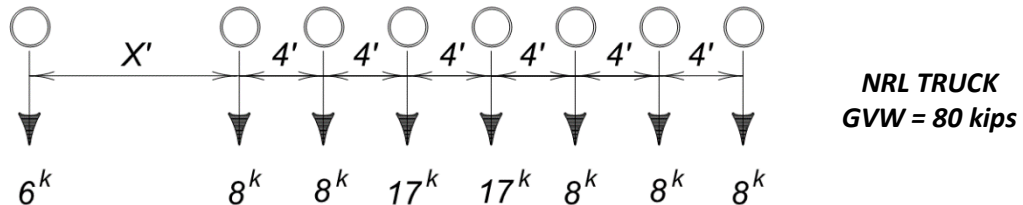

X is Variable from 6' - 0" to 14' - 0"

Axles that do not contribute to the maximum load effect under consideration shall be neglected.

Figure 3. Notional Rating Load (NRL) for Specialized Hauling Vehicles

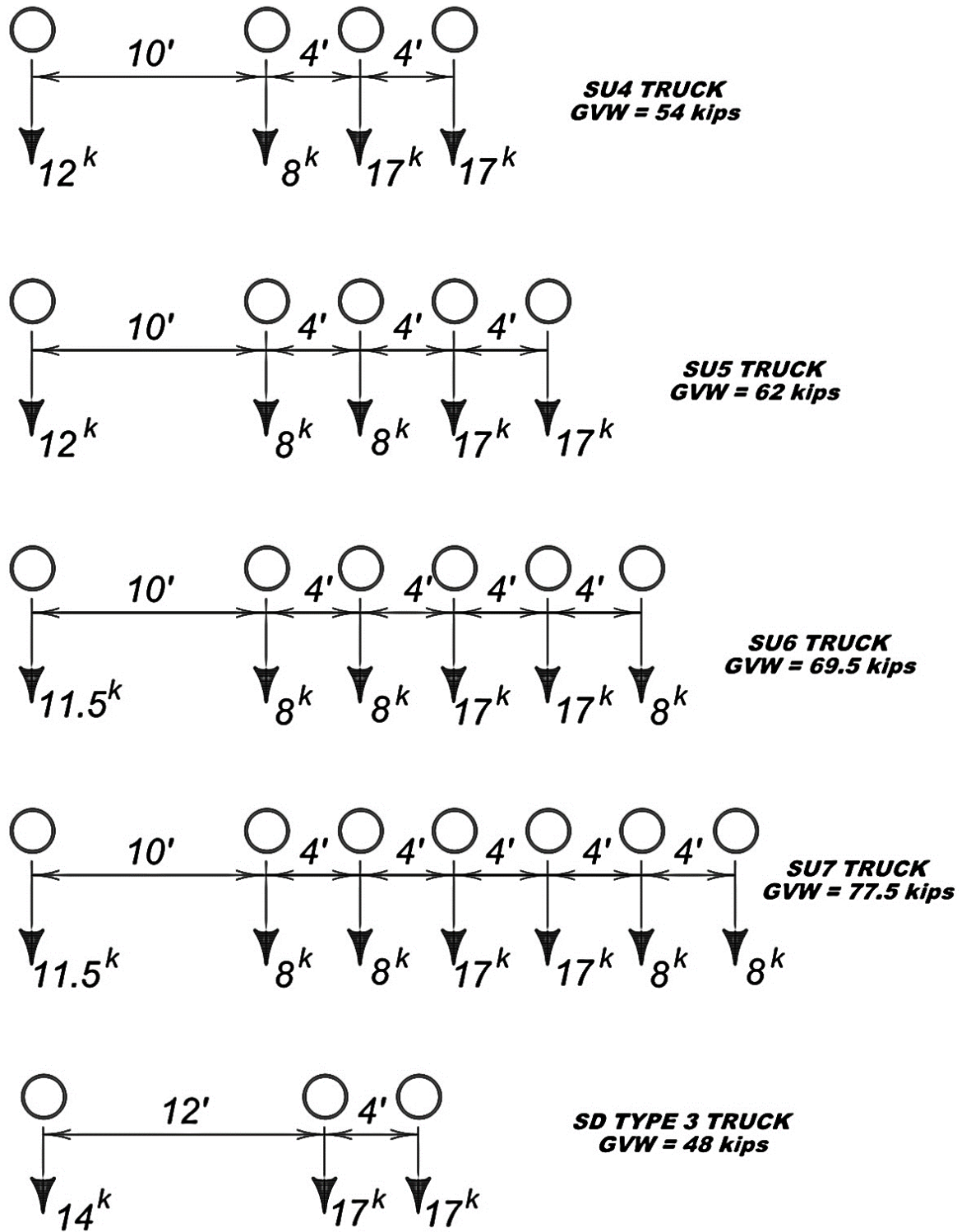

Figure 4. Single Unit Legal Loads for Posting

3.2.6 Strength Rating for Emergency Vehicles

The FAST Act signed in December 2015 exempted Emergency Vehicles (EVs) from meeting Interstate truck limits set forth in 23 U.S.C. 127(a) [https://uscode/text/23/127\(a\)](https://uscode/text/23/127(a)). All new structures shall be designed so that both EV2 and EV3 trucks rate 1.0 or higher.

The SDDOT follows the following guidance for load rating EV's from FHWA.

- November 3, 2016 Memorandum for Load rating for the FAST Act's Emergency Vehicles
<https://www.fhwa.dot.gov/bridge/loadrating/161103.cfm>
- *Questions and Answers - Load Rating for the FAST Act's Emergency Vehicles, Revision R01* dated March 16, 2018.
https://www.fhwa.dot.gov/bridge/loadrating/fast1410_qa.pdf

The use of the NCHRP report listed below on EV's is also permissible.

- NCHRP project 20-07/Task 410 *Load Rating for the FAST Act's Emergency Vehicles Ev-2 and Ev-3*, dated March 2019
http://onlinepubs.trb.org/onlinepubs/nchrp/docs/NCHRP20-07Task410FinalReport_March2019.pdf

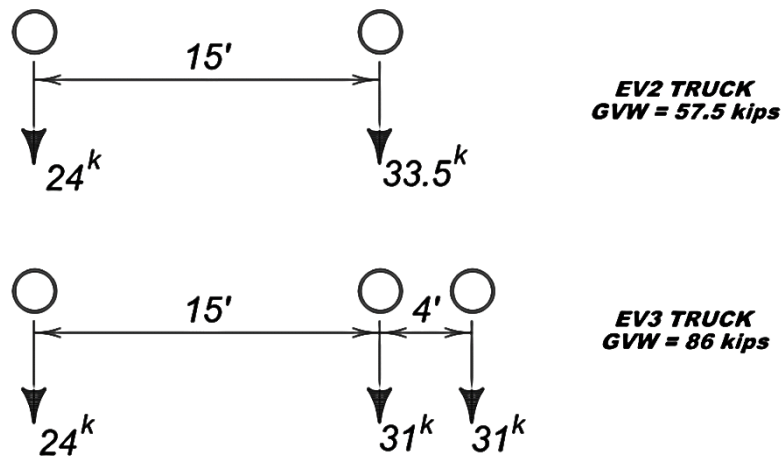

Figure 5. Emergency Vehicles for Posting

See Section 5.2 for information on load posting structures for Emergency Vehicles

3.2.7 Strength Rating for Overweight Permits

Single Trip Permits: Permits for single trip movements are issued for one-way or round-trip movement of overweight vehicles. These permits are valid only for the specific date, time, vehicle, and route designated in the permit.

Single trip permit analysis can be performed for single lane and multi-lane loading. If single lane loading is needed to approve an overload a restriction is required. When one-lane LRFD distribution factor is used, the built-in 1.2 multiple-presence factor should be divided out (That is, divide the computed one-lane distribution factor by 1.2 before using in the permit load rating). The permit vehicle will be placed laterally on the bridge, within the striped lanes, to produce maximum stresses in the critical member under consideration. The

dynamic load allowance may be reduced to 10% provided that the maximum vehicle speed is reduced to 5 MPH prior to crossing the bridge. If the truck is escorted across the bridge with no other vehicles allowed on the bridge during the crossing, the live load factor can be reduced from 1.4 to 1.1 as shown in Table 3.

Annual Permits: Annual permits are issued for the movement of overweight vehicles over a specified route or within a restricted area (usually a county or counties). Annual permits are usually valid for unlimited trips over a period not to exceed one year. The permit vehicle may mix in the traffic stream and move at normal speeds without any restrictions. Annual permit analysis will be performed using distribution factors for two or more lanes loaded.

The evaluation live-load factors, γ_L for permits for the Strength II limit state will be taken as given in Table 3. (Table MBE Table 6A.4.5.4.2a-1):

Permit Type	Frequency	Loading Condition	DF ^a	ADTT (one direction)	Load Factor by Permit Weight Ratio ^b		
					GVW / AL < 2.0 (kip/ft)	2.0 < GVW / AL < 3.0 (kip/ft)	GVW / AL > 3.0 (kip/ft)
Routine or Annual	Unlimited Crossings	Mix with traffic (other vehicles may be on the bridge)	Two or more lanes	>5,000	1.4	1.35	1.30
				=1,000	1.35	1.25	1.20
				<100	1.30	1.20	1.15
	Unlimited Crossings (Reinforced Concrete Box Culverts) ^c	Mix with traffic (other vehicles may be on the bridge)	One lane	All ADTTs	1.40		
					All Weights		
Special or Limited Crossing	Single-Trip	Escorted with no other vehicles on the bridge	One lane	N/A	1.10		
	Single-Trip	Mix with traffic (other vehicles may be on the bridge)	One lane	All ADTTs	1.20		
	Multiple Trips (less than 100 crossings)	Mix with traffic (other vehicles may be on the bridge)	One lane	All ADTTs	1.40		

Notes:

^a DF = LRFD-distribution factor. When one-lane distribution factor is used, the built-in multiple presence factor should be divided out.

^b Permit Weight Ratio = GVW/AL;. GVW = Gross Vehicle Weight; AL = Front axle to rear axle length; Use only axles on the bridge.

^c Refer to Article 6A.5.12.

Table 3: Permit Load Factors

See Appendixes D, E and F for current overload practices and examples.

3.2.8 Reduced Dynamic Load Allowance for Load Rating (Legal & Permit Loads)

Smoother riding surfaces may allow the Dynamic Load Allowance to be reduced from the LRFD design value of 33%, as shown in Table 4, for the Strength and Service limit states. When rating longitudinal members with spans greater than 40 feet with smooth or average approach and deck surface conditions, the Dynamic Load Allowance (IM) may be decreased for legal and permit vehicles. Dynamic load allowance will be applied to the

legal vehicles and not the lane loads. Regardless of riding surface condition, always use 33% for spans 40 ft or less and for transverse members. Selection of IM will be in accordance with the requirements of Section 3.1.4 and the Surface Roughness rating noted in the inspection report. State or document what value of IM was used for the load rating in the Load Rating Summary Form.

Riding Surface Rating	IM
Smooth - Smooth riding surface at approaches, bridge deck, and expansion joints	10%
Average - Minor surface deviations or depressions	20%
Poor - Significant deviations in riding surface at approaches, bridge deck, and expansion joints	33%

Table 4: Dynamic Load Allowance for Load Rating: IM.

3.3 RESISTANCE FACTORS AND RESISTANCE MODIFIERS FOR THE STRENGTH LIMIT STATES

3.3.1 Resistance Factor: ϕ

For Strength Limit States, member capacity is given as:

$$C = \phi_c \phi_s \phi R_n$$

Where:

ϕ_c = Condition Factor

ϕ_s = System Factor

ϕ = LRFD Resistance Factor

In addition, the following lower limit will apply:

$$\phi_c \phi_s \geq 0.85$$

Resistance factor ϕ has the same value for new design and for load rating. Resistance factors, ϕ , will be taken as specified in the LRFD Specifications for new construction. A reduction factor based on member condition, Condition Factor ϕ_c , is applied to the resistance of degraded members. An increased reliability index is maintained for deteriorated and non-redundant bridges by using condition and system factors in the load rating equation.

3.3.2 Condition Factor: ϕ_c

The condition factor provides a reduction to account for the increased uncertainty in the resistance of deteriorated members and the likely increased future deterioration of these members during the period between inspection cycles. Currently SDDOT allows the owner the option to use the values presented in Table MBE 6A.4.2.3-1.

Superstructure Condition of Member	ϕ_c
Good or Satisfactory	1.00
Fair	0.95
Poor	0.85

Table MBE 6A.4.2.3-1 Condition Factor: ϕ_c

The Condition Factor ϕ_c does not account for section loss but is used in addition to section loss. If section properties are obtained accurately, by actual field measurement of losses rather than by an estimated percentage of losses, the values specified for ϕ_c in Table 6A.4.2.3-1 may be increased by 0.05 ($\phi_c \leq 1.0$). For instance, a concrete member may receive a low condition rating due to heavy cracking and spalling or due to the deterioration of the concrete matrix. Deterioration of concrete components may not necessarily reduce their calculated flexural resistance, but it is appropriate to apply the reduced condition factor in the LRFR load rating analysis. Any section loss in the reinforcing steel should be measured and accounted for in the load rating. It is appropriate to also apply the reduced condition factor in the LRFR load rating analysis, even when the as-inspected section properties are used in the load rating as this reduction by itself does not fully account for the impaired resistance of the concrete component.

3.3.3 System Factor: ϕ_s

System factors are multipliers applied to the nominal resistance to reflect the level of redundancy of the complete superstructure system. Bridges that are less redundant will have their factor member capacities reduced, and, accordingly, will have lower load ratings. The aim of the system factor is to provide reserve capacity for safety of the traveling public. Current SDDOT policy is to use the system factors provided in Table MBE 6A.4.2.4-1 when load rating for Flexural and Axial Effects for steel members and non-segmental concrete members. The system factor is set equal to 1.0 when checking shear. Subsystems that have redundant members should not be penalized if the overall system is non-redundant (i.e. multi stringer deck framing members on a two-girder or truss bridge). System Factor is used with all live load models.

Superstructure Type	ϕ_s
Welded Members in Two-Girder/Truss/Arch Bridges	0.85
Riveted Members in Two-Girder/Truss/Arch Bridges	0.90
Multiple Eyebar Members in Truss Bridges	0.90
Three-Girder Bridges with Girder Spacing ≥ 6 ft	0.85
Four-Girder Bridges with Girder Spacing ≤ 4 ft	0.95
All Other Girder Bridges and Slab Bridges	1.00
Floorbeams with Spacing > 12 ft. and Non-Continuous Stringers	0.85
Redundant Stringer Subsystems Between Floorbeams	1.00

Table MBE 6A.4.2.4-1 System Factor: ϕ_s for Flexural and Axial Effects

Definitions

Floorbeam – A horizontal flexural member located transversely to the bridge alignment.

Stringer – A longitudinal beam supporting the bridge deck.

Girder – A large flexural member, usually built-up, which is the main or primary support for the structure, and which usually receives load from floorbeams, stringers, or in some cases directly from the deck.

3.4 RESISTANCE FACTORS AND RESISTANCE MODIFIERS FOR THE SERVICE LIMIT STATES

For all non-strength limit states, $\phi = 1.0$, $\phi_c = 1.0$, $\phi_s = 1.0$

3.5 SERVICE & FATIGUE LIMIT STATES FOR LOAD RATING

3.5.1 General Overview

Service and fatigue limit states to be evaluated during a load rating analysis will be as given below in Table 5:

Bridge Type	Limit State*	Dead Load DC	Dead Load DW	Design Load		Legal Load LL	Permit Load LL
				Inventory	Operating		
				LL	LL		
Steel	Service II	1.00	1.00	1.30	1.00	1.30	1.00
	Fatigue	0.00	0.00	0.80	—	—	—
Reinforced Concrete	Service I	1.00	1.00	—	—	—	1.00
Prestressed Concrete (non-segmental)	Service III	1.00	1.00	0.80	—	1.00	—
	Service I	1.00	1.00	—	—	—	1.00

* Defined in the AASHTO LRFD Bridge Design Specifications
Shaded cells indicate optional checks.

Table 5: LRFR Service and Fatigue Limit States and Load Factors

3.5.2 Concrete Bridges

For non-segmental prestressed concrete bridges, LRFR provides a limit state check for cracking of concrete (SERVICE III) by limiting concrete tensile stresses under service loads. The allowable tensile stress in the precompressed tensile zone for the inventory level design load rating, legal load rating, and permit load ratings is $0.19\sqrt{f'_c}$ in ksi units.

Service I and Service III limit states are mandatory for load rating of segmental concrete box girder bridges (MBE 6A.5.11.5.1).

A SERVICE I load combination for reinforced concrete components and prestressed concrete components has been introduced in LRFR to check for possible inelastic deformations in the reinforcing steel during heavy permit load crossings (MBE 6A.5.4.2.2b). This check will be applied to permit load checks and sets a limiting criterion in the extreme tension reinforcement. Limiting steel stress is intended to ensure that there is elastic behavior and that cracks that develop during the passage of overweight vehicles will close once the vehicle is removed. It also ensures that there is reserve ductility in the member.

3.5.3 Steel Bridges

Steel structures will satisfy the overload permanent deflection check under the SERVICE II load combination for design load, legal load and permit load ratings using load factors as given in Table 5. Maximum steel stress is limited to 95% and 80% of the yield stress for composite and non-composite compact girders respectively. During an overweight permit review the actual truck weight is available, so a 1.0 live load factor is specified.

In situations where fatigue-prone details are present (category C or lower) a Fatigue limit state Rating Factor for infinite fatigue life will be computed. If directed by SDDOT, bridge details that fail the infinite-life check can be analyzed with the more complex finite-life fatigue evaluation using evaluation procedures given in Section 7 of the MBE.

SECTION 4 LRFR LOAD POSTING GUIDELINES

4.1 LOAD POSTING REQUIREMENTS FOR BRIDGES

Strength limit state is used for checking the ultimate capacity of structural members and is the primary limit state utilized by SDDOT when LRFR is used to determine posting needs. Service and fatigue limit states are utilized to limit stresses, deformations, and cracking under regular service conditions. In LRFR, Service and Fatigue limit state checks are optional in the sense that a posting or permit decision does not have to be dictated by the result. These serviceability checks provide valuable information for the engineer to use in the decision process.

As explained in Section 2.6 a concrete bridge with unknown details may not need to be posted for (single or combination) vehicle loading if it has been carrying normal traffic for an appreciable period of time and shows no distress.

4.2 RELIABILITY-BASED POSTING

The goal of the LRFR methodology is to maintain target uniform reliabilities in all load ratings and load postings. Unlike past practice, it should be noted that in a reliability-based evaluation the relationship between posting values and rating factors is not proportional. For a posted bridge there is a greater probability of vehicles exceeding the posted limit compared to numbers exceeding the legal limit on an un-posted bridge. The MBE provides guidance on how to translate LRFR rating factors less than 1.0 into posting values that maintain the criteria of uniform reliability, especially for the low-rated bridges. This is achieved through a posting analysis equation, Eq. 6A.8.3-1 and a posting graph given in the MBE that presents posting weights for different vehicle types as a function of LRFR rating factors.

4.3 POSTING ANALYSIS

The bridge owner may consider using the reduction in Section 6 of the MBE when the rating factor (RF) for any legal truck is between 0.3 and 1.0.

When $0.3 < RF < 1.0$ the following equation can be used to establish the LRFR posting load for that vehicle type:

$$\text{LRFR Posting Load} = \frac{W}{0.7} [(RF) - 0.3]$$

MBE Equation (6A.8.3-1)

Where:

RF = Legal load rating factor
W = Weight of rating vehicle (Tons)

When the RF for any vehicle type falls below 0.3, then a recommendation should be made to not allow that vehicle type on the bridge. Other vehicle types with $RF > 0.3$ may continue to use the bridge. Posting recommendations will be added to the Load Rating Summary sheet.

SECTION 5 GENERAL LOAD POSTING GUIDLINES

5.1 LOAD POSTING REQUIREMENTS

NBIS regulations (23 CFR Part 650) require the load rating of each bridge to determine its safe loading capacity in accordance with the AASHTO Manual for Bridge Evaluation (MBE) and this document. When unrestricted legal loads exceed that allowed under the Operating or Legal rating levels the bridge must be posted in accordance with this document, the MBE or in accordance with state law. If a bridge is not capable of carrying statutory loads, it must be posted for a reduced load limit. The decision to load post a bridge will be made by the bridge owner based on an agency's load-posting practice. The guidelines are provided to assist SDDOT and local bridge owners in establishing posting weight limits. Bridges that are determined not capable of carrying 3 tons must be closed.

5.2 POSTING ANALYSIS FOR EMERGENCY VEHICLES

Use the guidance provided in the *FHWA Questions and Answers - Load Rating for the FAST Act's Emergency Vehicles* www.fhwa.dot.gov/bridge/loadrating/fast1410_qa.pdf including the flowchart on the next page. In South Dakota, only bridges carrying interstate traffic and bridges within reasonable (1 mile) access to the interstate currently need to be posted for Emergency Vehicles.

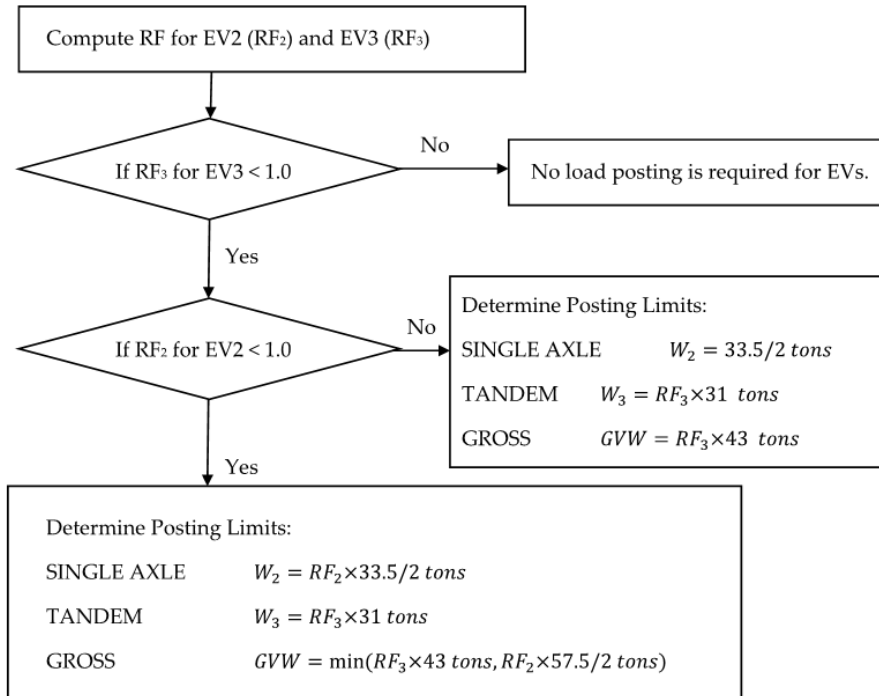

Figure 6. Flowchart for Posting Emergency Vehicles

5.3 POSTING SIGNS

In 2015 South Dakota discontinued use of the silhouette sign from the Manual for Uniform Traffic Control Devices (MUTCD) R12-5 because of difficulty in communicating the actual truck configuration and number of axles especially when considering specialized hauling vehicles.



Figure 7 - Discontinued R12-5 silhouette posting sign

South Dakota replaced the silhouette posting sign with signs that show the maximum limit for single unit and combination vehicles. If single unit vehicles require posting, but no combination vehicles require posting, it is permissible to use the “legal loads” sign option below.

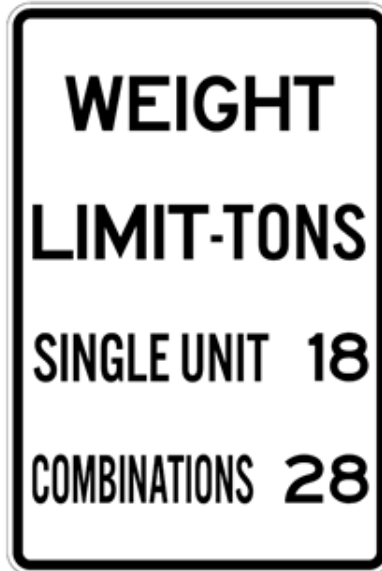

Figure 8 – Single Unit and Combinations posting signs (in use since 2015)

5.3.1 Single Unit Vehicles

A single unit vehicle is one that the power unit and truck body are permanently attached and can't be easily separated, regardless of number of tires, axles, etc. Post bridges for single unit vehicles based on the load rating of the SD Type3, SU4, SU5, SU6, and SU7 vehicles.



Figure 9 - Examples of Single Unit Vehicles

5.3.2 Combination Vehicles

Combination vehicles are those with a power unit and separable trailer or body. The SD Type 3S2 and SD Type 3-2 live loads are used to determine posting requirements for combination vehicles.

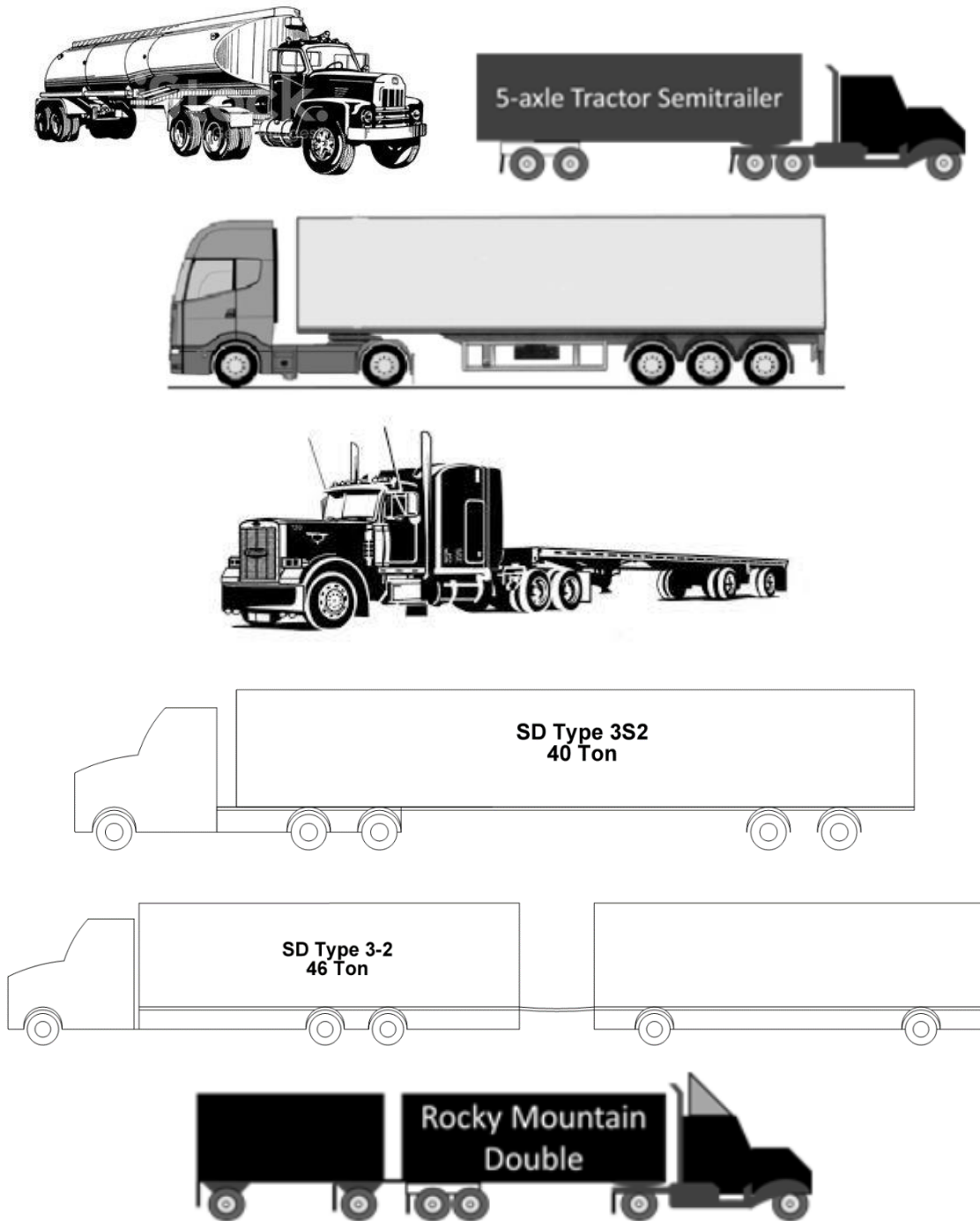

Figure 10 - Examples of Combination trucks

South Dakota uses posting signs from the Manual for Uniform Traffic Control Devices for gross weight and axle weight.



Figure 11 - MUTCD R12-1



Figure 12 - MUTCD R12-2



Figure 13. MUTCD R12-7 Standalone Emergency Vehicle posting sign in current use in South Dakota. Use this sign when only emergency vehicles need to be posted.



Figure 14. MUTCD R12-7aP Add-on Emergency Vehicle posting sign in current use in South Dakota. Use this sign in conjunction with another posting sign. Place EV posting sign below the other posting sign.

5.4 ENTERING POSTINGS IN BrM

Use the guidance below on to enter posting information concerning NBI items 41 and 70. The examples in the appendixes illustrate entering load postings in AASHTOWare BrM. Link to BrM: <https://brm.sd.gov/Login.aspx>

5.4.1 Item 41 – Structure Open, Posted, or Closed to Traffic

The actual operational status of the bridge should be reflected in this field. Because a bridge can be posted at a level below what is required it's possible to show a bridge posted in item 41 but posting not required in item 70. A bridge is considered posted if signed with any load posting sign. See section 5.3 for examples of posting signs recommended for use in South Dakota.

Code	Description
A	Open, no restriction
B	Open, posting recommended but not legally implemented (missing some signs or incorrectly implemented)
D	Open, would be posted except for temporary shoring, etc.
E	Open, temporary structure in place to carry legal loads while original structure is closed and awaiting replacement or rehabilitation.
G	New structure not yet open to traffic
K	Bridge closed to all traffic
P	Posted for load (may include other restrictions such as temporary bridges which are load posted)
R	Posted for other load-capacity restriction (speed, number of vehicles on bridge, etc.)

5.4.2 Item 70 –Posting

Code this item 0 – 4 if the load capacity for any of the SD Type 3, SD Type 3S2, SD Type 3-2, SU4, SU5, SU6, or SU7 vehicles at the legal/operating level requires posting. Code 5 if no posting is required for the SD Type 3, SD Type 3S2, SD Type 3-2, SU4, SU5, SU6, or SU7 vehicles. If posting is required only for emergency vehicles, code item 70 = 5.

Item 70 compares the load capacity of the bridge with SDDOT legal loads (SD Type 3, SD Type 3S2, SD Type 3-2, SU4, SU5, SU6, and SU7). Although posting a bridge for load-carrying capacity is required only when the maximum legal load exceeds the legal/operating capacity, bridge owners may choose to post at lower level. Posting at a lower level makes it possible to show a bridge posted in item 41 but posting not required in item 70.

If there is a temporary bridge present, the load capacity will reflect the actual capacity of the temporary bridge at the legal/operating level. This also applies to bridges shored up or repaired on a temporary basis.

The degree that the legal/operating rating is under the maximum legal loads is used to differentiate between codes. As a guide and for coding purposes only, the following values should be used to code this item.

ITEM 70 CODE	Relationship of legal/operating rating to Legal Load	Rating Factor	Single unit & Combination Posting
5	At/above legal loads	1.000 and up	Not Required
4	0.1 to 9.99% below	0.901 – 0.999	Required
3	10.0 to 19.99% below	0.801 – 0.900	Required
2	20.0 to 29.99% below	0.701 – 0.800	Required
1	30.0 to 39.99% below	0.601 – 0.700	Required
0	More than 39.99% below	0.000 – 0.600	Required

Example 1		Vehicle Wt. (Ton)	Legal Rating Factor	Legal Capacity (Ton)
SD Type 3S2	Combination	40	1.079	43.14
SD Type 3-2	Combination	46	0.981	45.12
SD Type 3	Single unit	24	1.085	26.03
SU4	Single unit	27	0.916	24.74
SU5	Single unit	31	0.858	26.59
SU6	Single unit	34.75	0.806	28.01
SU7	Single unit	38.75	0.806	31.23
EV2	Emergency	28.75	0.903	25.97
EV3	Emergency	43	0.595	25.58

Example 1: Consider only the legal level ratings for SD Type 3, SD Type 3S2, SD Type 3-2, SU4, SU5, SU6, and SU7 vehicles. Since the lowest legal rating factor for any of these vehicles is in the range of 0.801 to 0.900 use code 3 (10.0 to 19.99% below).

Posting (070):

Example 2		Vehicle Wt. (Ton)	Operating Rating Factor	Operating Capacity (Ton)
SD Type 3S2	Combination	40	0.907	36.3
SD Type 3-2	Combination	46	0.806	37.1
SD Type 3	Single unit	24	1.122	26.9
SU4	Single unit	27	1.102	29.8
SU5	Single unit	31	1.003	31.1
SU6	Single unit	34.75	0.819	28.5
SU7	Single unit	38.75	0.792	30.7
EV2	Emergency	28.75	0.902	25.9
EV3	Emergency	43	0.624	26.8

Example 2: Consider only the operating level ratings for SD Type 3, SD Type 3S2, SD Type 3-2, SU4, SU5, SU6, and SU7 vehicles. Since the lowest operating rating factor for any of these vehicles is in the range of 0.701 to 0.800 use code 2 (20.0 to 29.99% below).

Posting (070):

SECTION 6 LOAD RATING DELIVERABLES

6.1 LOAD RATING REPORTS

6.1.1 Load Rating Report Requirements for Consultants and Fabricators

All load rating reports submitted to the SDDOT must have:

- a load rating summary sheet
- load rating calculations, rating check calculations, and documentation
- BrR input data and a BrR model (when applicable).

The first sheet of the load rating report will be the appropriate Load Rating Summary Sheet that can be found at <https://dot.sd.gov/transportation/bridges/reference-information>. See Appendix C for samples of the load rating summary sheets.

Load rating calculations and documentation will be incorporated into a comprehensive report to facilitate updating of the information and calculations in the future. The report will summarize the live load distribution factors used for each member, critical load ratings for each vehicle, controlling force effect, and location of the controlling force effect. The load rating should be completely documented in writing including all background information such as field inspection reports, material, and load test data, all supporting computations, and a clear statement of all assumptions used in calculating the load rating. Sketches will be provided to document section losses incorporated in the analysis. Inspection reports, testing reports, and articles referenced as part of the load rating will be documented. When refined methods of analysis or load testing are used, the load rating report will include live load distribution factors for all rated members, determined through such methods. Since LRFD is required for new, replaced, and rehabilitated structures submit the LRFR ratings for these with plans or shop plans.

As stated in section 2.5, if a bridge is capable of being defined within the parameters of the BrR software, it must be rated using BrR. The load rating report submitted to the SDDOT must include BrR input data, an exported BrR xml file of the load rating model, and any computer models used in the analysis with documentation.

6.1.2 Load Rating Documentation Required for Bridge Office Personnel

All structures capable of being rated in BrR must have a current model in the BrR database. The structure file will document controlling load ratings, load effects, members, and locations. Only posted state structures require a Load Rating Summary sheet.

6.2 QUALITY CONTROL AND QUALITY ASSURANCE REVIEW OF LOAD RATINGS

Quality control procedures are intended to maintain the quality of bridge load ratings and are usually performed continuously within the load rating teams/units. When Consultants perform load ratings, the consultant will have quality control procedures in place to assure the accuracy and completeness of the load ratings. When computer programs are used, the load raters will perform necessary independent checks to validate the accuracy of the load rating results generated by the program. Part of the quality control procedures should include verifying all input data, verifying that the summary of load capacity information accurately reflects the analysis, and that any computer programs used are suitable for the analysis required and sufficiently accurate.

Quality assurance procedures are used to verify the adequacy of the quality control procedures to meet or exceed the standards established by the agency or the consultant performing the load ratings. Quality assurance procedures are usually performed independent of the load rating teams on a sample of their work. Guidance on quality measures for load rating may be found in MBE Article 1.4.

6.3 QUALITY CONTROL OF LOAD POSTINGS

For state owned structures, the SDDOT Office of Bridge Design will notify the Region when a bridge requires posting. Immediately after the bridge is posted by Region staff, an email must be sent to the Bridge Office to confirm that the signs are installed.

All state and locally owned bridges must be posted within 30 days of the time a load rating determines posting is required (April 17, 2019, FHWA memorandum).

<https://www.fhwa.dot.gov/bridge/nbis/190417.pdf>

Verification of the posting will be confirmed at each bridge inspection. All posting signs must display the same information. The number of posting signs and photo of a typical sign will be documented at each inspection. Weight limit signs will conform to the requirements in Section 5 of this document and as stated in the MBE.

Appendix A: LRFR Posting Example

Bridge A was built in 1956 and is 1.8 miles from interstate access. The LRFR legal ratings pertinent to load posting the structure are shown below. Load ratings lower than 1.0 are highlighted.

The owner prefers not to use MBE Eq. (6A.8.3-1) to determine the posting load.

1. Since at least one of the single unit rating vehicles has a rating factor < 1, single unit vehicles require posting. Post single unit vehicles at 24 tons, the lowest capacity of any of the single unit vehicles.

Vehicle	Vehicle Type	Vehicle Wt. (Ton)	Legal Rating Factor	Legal Capacity (Ton)
SD Type 3S2	Combination	40	1.079	43.14
SD Type 3-2	Combination	46	0.981	45.12
SD Type 3	Single unit	24	1.085	26.03
SU4	Single unit	27	0.916	24.74
SU5	Single unit	31	0.858	26.59
SU6	Single unit	34.75	0.806	28.01
SU7	Single unit	38.75	0.806	31.23
EV2	Emergency	28.75	0.903	25.97
EV3	Emergency	43	0.595	25.58

2. Posting for combination vehicles is required since at least one of the

combination rating vehicles has a rating factor less than 1. Post at 43 tons, the lowest capacity in tons for any of the combination vehicles.

3. Posting for Emergency vehicles isn't required even though both EV vehicles have rating factors less than 1 because the bridge isn't within a mile of interstate access.
4. In BrM enter "B" for item 70 if signs aren't installed yet, or "P" as soon as posting signs are correctly installed. Code item 70 with a "3" for "10.0% to 19.99% below" due to the lowest legal rating factor in 0.801 – 0.900, post singles at 24 T and combinations at 43 T using the sign on the next page.

Posting (070):

Using the same bridge and load ratings, determine the posting load using MBE Eq. (6A.8.3-1). Use the equation only when the rating factor (RF) for a legal truck is between 0.3 and 1.0. The calculations are shown below in red text.

$$\text{Safe Posting Load} = \frac{W}{0.7} [(RF) - 0.3] \quad \text{MBE Eq. (6A.8.3-1)}$$

for SD Type 3-2 LRFR posting load = $46/0.7 \times (0.981-0.3) = 44.8$ Tons

for SU4 LRFR posting load = $27/0.7 \times (0.916-0.3) = 23.8$ Tons

for SU5 LRFR posting load = $31/0.7 \times (0.858-0.3) = 24.7$ Tons

for SU6 LRFR posting load = $34.75/0.7 \times (0.806-0.3) = 25.1$ Tons

for SU7 LRFR posting load = $38.75/0.7 \times (0.806-0.3) = 28.0$ Tons

5. Since one or more of the single unit rating vehicles has a rating factor < 1, single unit vehicles require posting. The LRFR posting loads vary between 23.8 tons and 28.0 tons, so single unit vehicles should be posted at 23 tons.
6. Posting for combination vehicles is required since at least one of the combination rating vehicles has a rating factor less than 1. Post at 43 tons, the lowest capacity in tons for any of the combination vehicles.

7. Posting for Emergency vehicles isn't required even though both EV vehicles have rating factors less than 1 because the bridge isn't within a mile of interstate access.
8. To summarize, post singles at 23 T and combinations at 43 T using the sign below right. Note that the combination posting is still controlled by the SD Type 3-2 capacity.

Sign without posting load reduction



Sign with posting load reduction



Appendix B: LFR Posting Example

Bridge B was built in 1966 and is 0.4 miles from interstate access. The vehicles and operating ratings pertinent to load posting the structure are shown below. Load ratings lower than 1.0 are highlighted.

- Since at least one of the single unit rating vehicles has a rating factor < 1, single unit vehicles require posting. The single unit operating capacities are shown in red text. Post single unit vehicles at 29 tons, the lowest capacity for any of the single unit vehicles. Note that the SD Type 3 and SU4 vehicles determine the posting load even though the RF > 1 for these vehicles.

Vehicle	Vehicle Type	Vehicle Wt. (Ton)	Operating Rating Factor	Operating Capacity (Ton)
SD Type 3S2	Combination	40	1.207	48.3
SD Type 3-2	Combination	46	1.194	54.9
SD Type 3	Single unit	24	1.227	29.5
SU4	Single unit	27	1.096	29.6
SU5	Single unit	31	1.003	31.1
SU6	Single unit	34.75	0.919	31.9
SU7	Single unit	38.75	0.892	34.6
EV2	Emergency	28.75	1.152	33.1
EV3	Emergency	43	0.724	31.1

- Enter load rating information into BrM:

On the INSPECTION>APPRAISAL Tab enter data in relevant fields:

Design Load (031): 5 MS 18 (HS 20)

Posting (070): 3 10.0-19.9%below

Operating Type (063): 1 LF Load Factor

Operating Rating (064): 56.9 ton

Inventory type (065): 1 LF Load Factor

Inventory Rating (066): 37.8 ton

Operating

SD Type 3: 29.5 ton

SD Type 3S2: 48.3 ton

SD Type 3-2: 54.9 ton

SHVs

SU4: 29.6 ton

SU5: 31.1 ton

SU6: 31.9 ton

SU7: 34.6 ton

NRL: 35.5 ton

3. Neither of the combination vehicles require posting, but a value must be included on the posting sign since single unit vehicles require posting. Posting should be at either
 - a. the lowest capacity in tons for any of the combination vehicles; 48 tons
 - or
 - b. "LEGAL LOADS" since both combination rating vehicles rate > 1



4. Posting for Emergency vehicles is required because the bridge is within a mile of interstate access and at least one EV vehicle has a rating factor < 1 . The following flowchart illustrates the steps and calculations involved in posting for EV's.

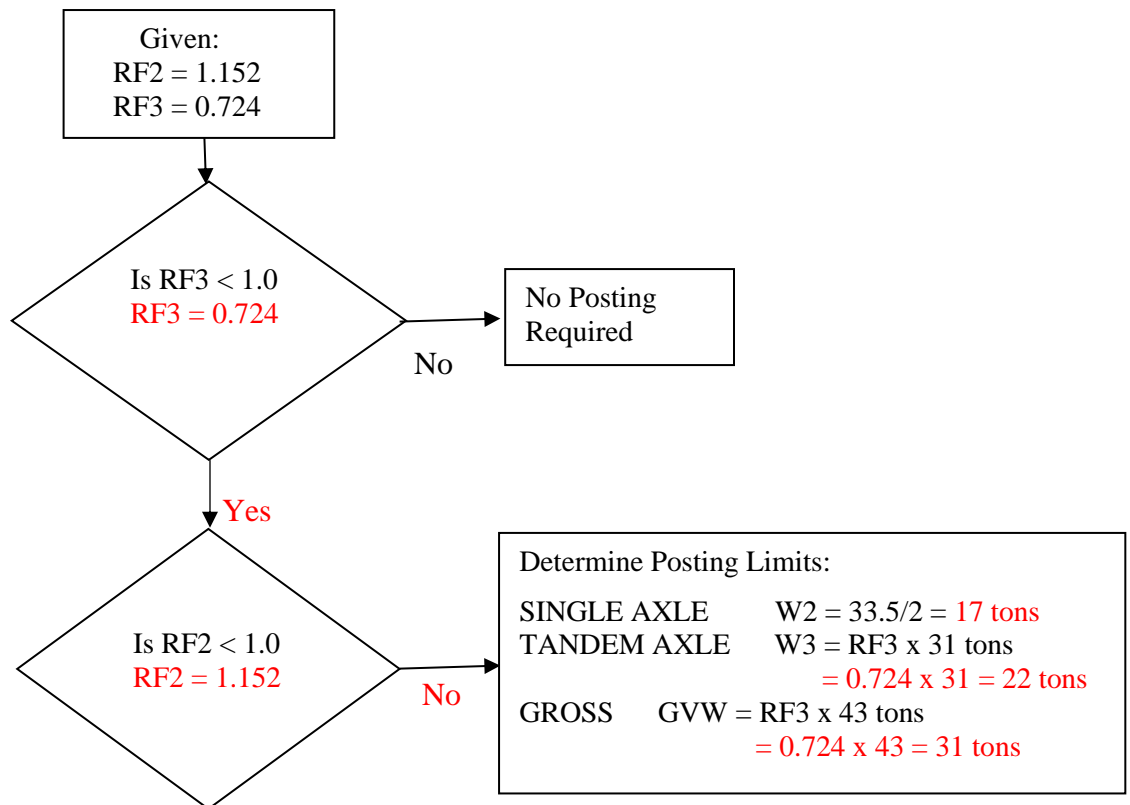

5. SDDOT allows posting the single axle EV at 17 tons when the EV2 rates > 1 only because posting example 2 in www.fhwa.dot.gov/bridge/loadrating/fast1410_qa.pdf shows this. Round all other calculated posting values down.

6. Post the bridge with the signs shown below. The Emergency vehicle sign should be below the single unit/combinations posting sign. Enter required information on the INSPECTION>INVENTORY>AGENCY ITEMS tab.

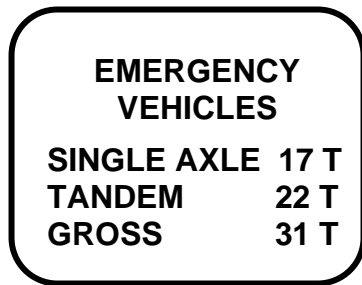

Inspection > Inventory > Agency Items

Agency Bridge Items

EV2 (tons):	33.1
EV3 (tons):	31.1
EV single posting:	17
EV tandem posting:	22
EV gross posting:	31
SU Posting (tons):	29
Comb Posting (tons)	legal loads
Post only EV (Y/N):	N
EV Posting Required	Y
EV sign installed (Y/N)	Y
All signs installed:	Y
BrR model:	Y
Plans Available:	yes
14:	
EV Rating Required	Y

Appendix C: Sample Load Rating Summary Sheets

Get Load Rating Summary Sheets at:

<https://dot.sd.gov/transportation/bridges/reference-information>

LOAD RATING SUMMARY SHEET for Bridges in South Dakota

Bridge Data						
Structure Number	-	-	Inspection Date	Condition	- Insert Condition -	
County			Year Built	Deck Rating	- Insert Condition -	
Route			Design Load	Super Rating	- Insert Condition -	
Feature Intersected			Roadway Width	Sub Rating	- Insert Condition -	
Bridge Type			ADTT (one way)			
Bridge Length			Steel or Timber Abutment or Bent Caps			
Bridge Load Rating Summary						
Dead Load			LRFR Evaluation Factors:			
Wearing Surface Thickness			Surface Roughness Rating			
Wearing Surface Type			Condition Factor			
Non-structural attachments			System Factor			
Rating Method	<input type="checkbox"/> LFR	<input type="checkbox"/> ASR (Timber Only)	Comments:			
	<input type="checkbox"/> LRFR	<input type="checkbox"/> Field Evaluation				
Bridge Rating Summary						
Vehicle Type	GVW (Tons)	Rating Factor	Rating (Tons)	Controlling Member / Load effect	IM	Live Load Distribution factor
- Insert -	N/A					
- Insert -	N/A					
SD Type 3	24.0					
SD Type 3S2	40.0					
SD Type 3-2	46.0					
SU4	27.0					
SU5	31.0					
SU6	34.75					
SU7	38.75					
NRL	40.0					
EV2	28.75					
EV3	43.0					
Posting Analysis Summary			Please Check the following boxes that apply:			
Governing Rating Factor			<input type="checkbox"/> Plans do not exist (assign & document load rating)			
Governing Load Model			Load rating is governed by:			
BrR Model (Y/N)			<input type="checkbox"/> Deck			
			<input type="checkbox"/> Substructure			
			<input type="checkbox"/> Exterior Girder			
			<input type="checkbox"/> Connections			
QC/QA	Name	Date	<input type="checkbox"/> BrR <input type="checkbox"/> Other:			
Rated						
Checked						
QA						

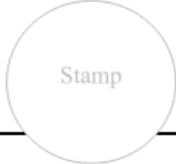

Posting Required : Indicate which signs are needed and give recommended Posting loads

<input type="checkbox"/> Single units and Combinations	<input type="checkbox"/> Gross weight	<input type="checkbox"/> Axle weight	<input type="checkbox"/> Emergency Vehicle add-on sign	<input type="checkbox"/> Emergency Vehicle stand-alone sign
--	---------------------------------------	--------------------------------------	--	---

WEIGHT LIMIT-TONS

SINGLE UNIT

COMBINATIONS

WEIGHT LIMIT TONS

AXLE WEIGHT LIMIT TONS

EMERGENCY VEHICLES

SINGLE AXLE T

TANDEM T

GROSS T

EMERGENCY VEHICLE WEIGHT LIMIT

SINGLE AXLE T

TANDEM T

GROSS T

LOAD RATING SUMMARY SHEET for Culverts in South Dakota

Culvert Data

Structure Number	-	-	Fill Height	Inspection Date
County			Year Built	Condition - Insert Condition -
Route			Design Load	Culvert Rating - Insert Condition -
Feature Intersected			Roadway Width	
Culvert Type			ADTT (one way)	
Culvert Length				

Culvert Load Rating Summary

Dead Load

Wearing Surface Thickness

Wearing Surface Type

Non-structural attachments

Rating Method LFR ASR (Timber Only)
 LRFR Field Evaluation Comments:

Culvert Rating Summary

Vehicle Type	GVW (Tons)	Rating Factor	Rating (Tons)	Controlling Member / Load effect	IM	Live Load Distribution factor
- Insert -	N/A					
- Insert -	N/A					
SD Type 3	24.0					
SD Type 3S2	40.0					
SD Type 3-2	46.0					
SU4	27.0					
SU5	31.0					
SU6	34.75					
SU7	38.75					
NRL	40.0					
EV2	28.75					
EV3	43.0					

Posting Analysis Summary

Governing Rating Factor

Governing Load Model

BrR Model (Y/N)

Please Check the following box if applicable:
 Plans do not exist (assign & document load rating)

QC/QA	Name	Date
Rated		
Checked		
QA		

Rating Software BrR Other:

Stamp

Posting Required : Indicate which signs are needed and give recommended Posting loads

Single units and Combinations

Gross weight

Axle weight

Emergency Vehicle add-on sign

Emergency Vehicle stand-alone sign

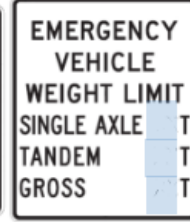

Appendix D: Bridge Office Overload Procedures

South Dakota currently uses the South Dakota Automated Permitting System (SDAPS) <https://sdaps.sd.gov/sdaps> to issue overweight permits. The Highway patrol issues all permits, helps enter and route permits, and does permit enforcement. SDAPS uses load factor rating (LFR) to analyze all bridge structures for a given truck configuration along a proposed route. A bridge designed using LRFD will have LRFR ratings reported as part of the NBI, but overloads may be evaluated using LFR. Permits can be automatically issued if there are no failed bridges on the route. In SDAPS a failed bridge is a bridge that SDAPS has calculated an operating rating factor (RF) that is less than 1.0 for the permitted load even when restricted to 5 mph and with the overload the only vehicle allowed on the bridge. Restricting the overload speed to 5 mph allows the liveload impact/dynamic load allowance to be reduced to 10%. Restricting the overload to travel alone down the bridge centerline allows single lane distribution factors to be used since loading from other vehicles doesn't need to be considered.

When failed bridges occur an automated email from SouthDakota.Permits@state.sd.us is sent to staff in the bridge office designated to analyze overloads. The person assigned to the overload signs into SDAPS with their username and password and searches for pending overload applications. To get information on the overweight load, restrictions, trip, and the rating factors of bridges on the route choose the Trip, Restrictions, and Review tabs in SDAPS.

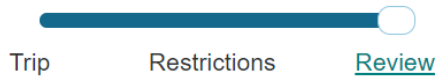

View the axle configuration and truck display in SDAPS.

	1	2	3	4	5	6	7	8	9	10	11	12
Weight:	12000	15333	15334	15333	16666	16667	16667	20000	20000	20000	21000	21000
Number of Tires:	2	4	4	4	4	4	4	4	4	4	4	4
Tire Width:	425	275	275	275	255	255	255	255	255	255	255	255
Axle Width:	8' 6"	8' 6"	8' 6"	8' 6"	8' 6"	8' 6"	8' 6"	8' 6"	8' 6"	8' 6"	8' 6"	8' 6"
Axle Spacing:	15' 0"	4' 6"	4' 6"	10' 1"	4' 6"	4' 6"	32' 0"	4' 6"	4' 6"	14' 1"	4' 6"	4' 6"

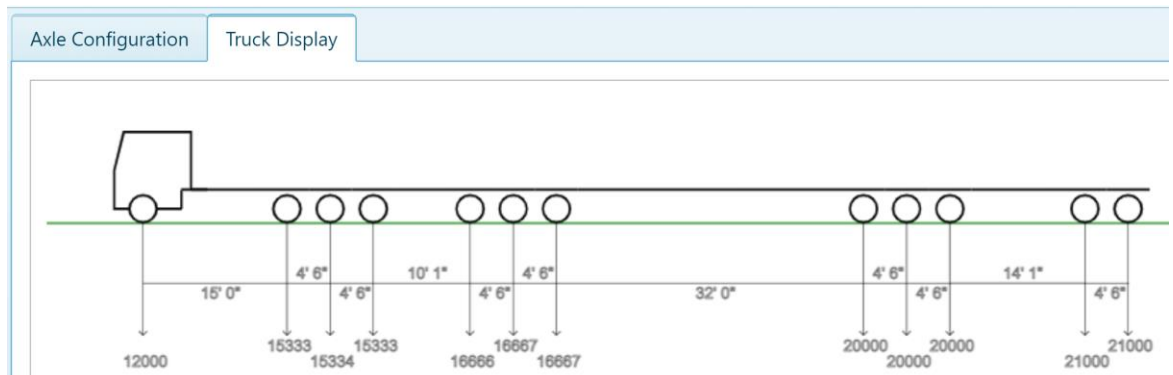

- Review the list of failed bridges in SDAPS on the Trip > Report Summary > [Tab](#)

Report Name	View in
Summary	Tab Bottom Right
Clearance	Tab Bottom Right
Restriction	Tab Bottom Right
Bridge Ratings	Tab Bottom Right

- Open AASHTOWare BrR (connect to the Bridge Rating database) and create a truck model for the overload. For most overloads it's usually best to start creating a standard gage truck model by clicking on the VIEW and Library tabs shown in the following screenshots. On standard gage trucks the center-to-center wheel spacing is fixed at 6' on all axles. Axle widths in SDAPS are shown to the outside of the tires with an 8-foot width assumed standard gage.

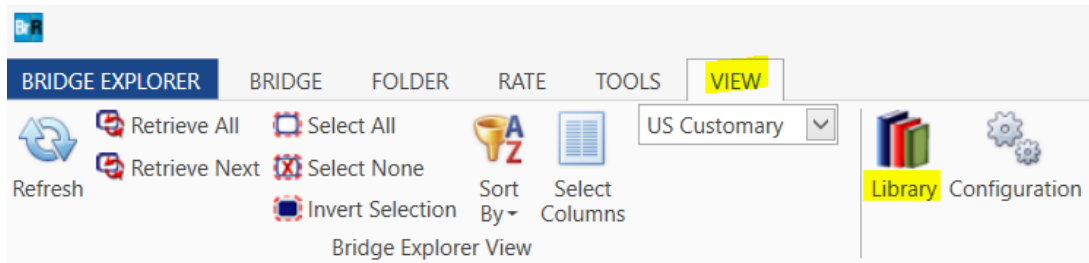
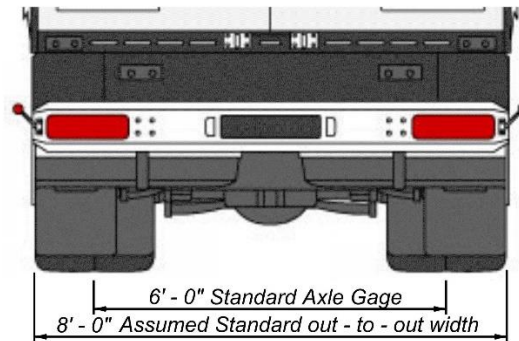

Select a Standard Gage vehicle from near the bottom of the library tree.

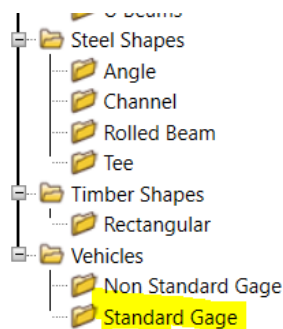

- If all the axle widths are 8 feet or less, create a vehicle with the axle weights and spacings given in SDAPS.
- Over-width Axles:** For any axle widths between 8 feet and 16 feet reduce the axle weight a maximum of 15% (multiply by 0.85) based on the ratio of an 8' axle to the actual axle width.
 - For a 21-kip axle weight on an 8.5' wide axle, this axle weight reduction results in $8/8.5 = 0.941 > 0.85$, since this is less than a 15% reduction reduce

the axle weight by multiplying by 0.941. The reduced axle weight = 21k * 0.941 = 18.765k.

- For a 21-kip axle weight on a 10' wide axle, this axle weight reduction results in $8/10 = 0.80 < 0.85$, the 15% maximum reduction controls so reduce the axle weight by multiplying by 0.85. The reduced axle weight = 21k * 0.85 = 17.85k.
- For axle widths greater than 10' the load rater needs to determine if it is appropriate to use single lane distribution factors. An axle with 8 tires over a 14' width occupies significant parts of two lanes and isn't modeled well as a single-lane load. If in doubt use non-standard gage analysis when appropriate to determine LL distribution factors and load rating.
- For axle widths 16 feet wide or greater (often side-by-side trailers), try to minimize the number of non-standard gage runs needed by modeling the overload as two adjacent trucks. Divide the axle weights in half for just the wide (>16") axles and only use multi-lane rating factors (**ignore ratings for single lane loading**).
- Check that the vehicle is entered correctly by looking at the total weight, length, and truck schematic.
- Highlight the bridges in BrR, right click and choose [Rate](#).

1549	41061057	41061057
131	41063178	41063178
706	41077137	41077137
493	41080057	41080057
492	41080058	
2155	41084057	
2211	41091057	
1551	41091058	
1552	41091059	
465	41091213	
1056	41092058	
1057	41092059	
469	41094010	

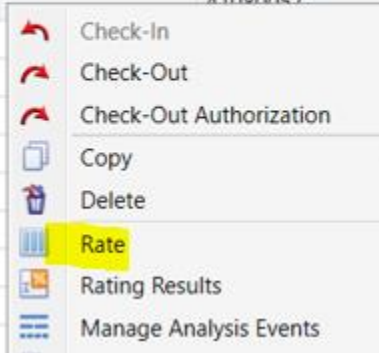

Rate using these options:

- Rating method: [LFD](#) (consider rating some bridges especially newer ones LRFR)
- Analysis type: [Line Girder](#)
- Lane/Impact loading type: [Detailed by Vehicles](#) (As Requested can work also)
- Review the list of failed bridges in SDAPS on the Trip Tab > View Summary.
- Trusses and bridges with stringers or floorbeams need to be checked out in BrR to rate the entire superstructure. Bridges that need to be checked out include:
 - 07-100-328 (Aberdeen Truss)
 - 08-061-094 (I90 at Chamberlain)
 - 08-068-084 (I90L at Chamberlain Truss)
 - 12-085-080 (Platte-Winner Bridge)
 - 54-056-158 (Forest City Bridge)
 - 65-000-020 (US12 at Mobridge)
- Select the overload vehicle and add it under the Operating heading.

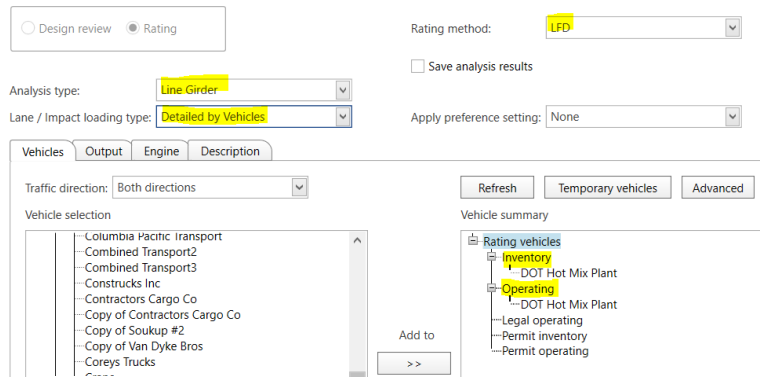

- Click
- If the Operating Rating ≥ 1 for the multilane loading. No restrictions are needed for the bridge.
- For Operating Ratings < 1 , look at increasing the rating factor by adding a restriction. A restriction requires the overload to travel at 5 mph down the middle of the bridge. Pilot cars are usually required to ensure the overload is the only vehicle on the bridge.
 - Use single lane loading (when applicable)

- Use the single lane rating in BrR (Detailed by Vehicles)
- Alternately use single lane distribution factors on girder bridges by applying the ratio of the single lane and multi-lane liveload distribution factors (should have an interior beam controlling and sufficient bridge width so that the majority of the load is applied to the interior beams).

$$(S/7.0)/(S/5.5) = 1.273$$

$$\text{Single lane RF} = 1.273 * \text{multi-lane RF}$$
- Single lane loading can be used on trusses by choosing the **Advanced** tab on the Analysis Setting window and enabling the checkbox under Single lane loaded.



- Note single lane loading doesn't help on concrete slab bridges when using LFR because for these structures there is usually no distinction between single and multi-lane distribution factors.
- When speed is reduced to 5 mph with a restriction, the bridge office policy is to reduce impact to 10%
 - Get the impact used by opening the bridge in BrR. Analyze the superstructure definition or controlling member for your truck. When the analysis is completed select the member you need the impact for in the model's tree. Select **Tabular Results**, then Report Type: **Live Load Actions**. Look at the % Impact Reactions. Select the impact value corresponding to the location of the controlling rating.

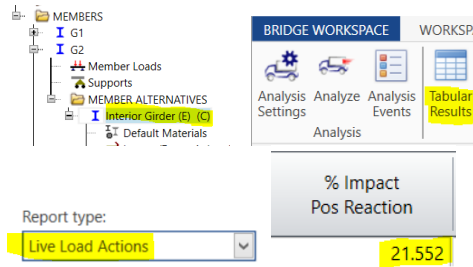

In this case, the % impact is 21.552%.

- Use the equation below to reduce impact to 10%

$$RF \text{ low impact} = \frac{(1 + \%Impact) * Operating RF \text{ with Impact}}{1.10}$$

- Alternately it's possible to use the ratio of the low impact/full impact rating values for the bridge in SDAPS. Make sure to use values for the same loading condition (single or multi-lane) for the ratio. On this bridge the RF with impact = 0.75. The RF with low impact = 0.83, therefore the RF adjustment for low impact would be $0.83/0.75 = 1.107$

For this girder bridge example:

Multi-lane Operating RF with impact = 0.75 (from SDAPS)
 Multi-lane Operating RF with low impact = 0.83 (from SDAPS)
 Single lane Operating RF with impact = 0.96 (from SDAPS)
 Impact = 1.2155 (from BrR)

$$RF = 0.75 * (S/7.0)/(S/5.5) * (0.83/0.75) = 1.06 > 1.0$$

$$\text{or } (0.96) * (1.2155/1.1) = 1.06 > 1.0$$

Since the $RF \geq 1$, the overload can cross this bridge while restricted to 5 mph and as the only vehicle on the bridge traveling down the center.

- A restriction is needed for the bridge if single lane loading and/or reduced impact is needed to get the overload's $RF \geq 1$. Add the restriction in SDAPS before approving the permit.
- You may need to click the **Override Analysis** checkbox on the Trip page to navigate back to the other pages.
- Special Structure Types**
 - Timber bridges** are not designed or analyzed with impact, therefore, the rating factor for low impact does not increase. Timber bridges need to be rated ASR or LRFR. Currently the only bridge with a timber superstructure on the state system that is allowed to carry overloads is SD244 over Palmer Gulch, structure number 52-261-428 (due to be replaced by 2023).
 - Trusses:** An alternate option to use single lane loading on trusses (for load factor analysis) can be accomplished by using the following method. Often trusses have a governing tension or compression member control (i.e. U2L3

or L1L2). To calculate the rating when the overload is the lone vehicle on the truss, find the Live Load distribution factor (LL DF) for the truss members from BrR. The capacity can be increased based on 1 vehicle (single lane loading) on the truss.

$$(RF) * (LL DF)/1.5 = \text{Restricted single lane RF}$$

- **Concrete Rigid Frames:** BrR out-of-the-box doesn't model the backwalls and earth pressure on these structures. Currently hand analysis is required for these structures. It may help to reference the consultant load ratings done in 2020 for these structures.
- **Culverts:** Culverts aren't supported in LARS/Superload. Because the fill over these structures helps to distribute the loading and most are short structures that limit the number of loaded axles, SDDOT doesn't normally check overloads on culverts. An exception is that new box culverts are checked for construction loading when scrapers are anticipated to cross the structure during construction.
- **Framed Bent on Pile:** use the increased capacity based on the live load distribution being increased by 1.3E. The comment section (for example) will state "S2 = 1.3 X E".
- **Bridges with No Overloads Allowed**
 - **Posted Structures:** Structures posted for Single Unit or Combination vehicles are not allowed to carry overloads. Bridges posted only for emergency vehicles can still carry overloads. The current list of posted structures is available at: <https://dot.sd.gov/media/BridgePostingList.pdf>
 - **Select Other bridges:** Overloads aren't allowed on
 - 09-060-089, SD47 over Soldier Creek
 - 17-289-107, SD87 over French Creek
 - 33-100-118, US14/US83/SD34 over the Missouri River
 - 50-280-136, SD11 over West Pipestone Creek
 - 52-308-411 and 52-308-412, Keystone Wye bridges
 - any bridges specified as "No Overloads Allowed" in the route restriction email updates.
- **Non-Standard Gage (NSG) Vehicles**
 - A standard wheel gage of 6 feet (8 feet wide out-to-out as shown in SDAPS) is used for all design and the rating vehicles used for posting. Some overloads involve significantly wider axles. Enabling BrR to calculate liveload distribution factors for actual axle configurations on the overload applied to the specific superstructure cross-section can result in higher load ratings. Non-standard gage analysis works for bridges with girder spans but does not work for slab spans.
 - Create a non-standard vehicle with axle spacing and weights for the overload in the BrR library.

- It's even more important with NSG vehicles to review the schematic to make sure all axles are entered correctly.
- Rate the bridge(s) requiring non-standard gage analysis.
- Choose Analysis type: **Distribution Factor – Line Girder** and run the analysis.

Analysis type: **Distribution Factor-Line Girder**

- Reduce impact if needed.
- Options for adjusting the lane position of NSG vehicles on the bridge are possible as shown on the following screenshot.

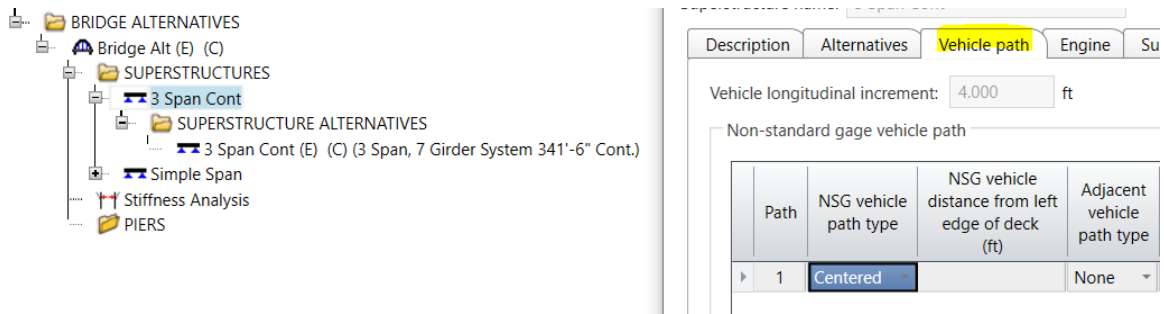

- In SDAPS select **Approve** (after entering any new restrictions), **Reject** or **Return to Permit Office**. Do not find alternate routes or truck configurations if the load doesn't rate equal to or greater than 1. Enter a summary in the overload log spreadsheet at <\\State.sd.local\work\TRPR1\br\Misc\Overloads\LogBook.xls> and designate who is scheduled to check the next overload.
- Occasionally an individual will either call or physically come into the office. Explain to the person that all permit requests need to go through a Port of Entry at (605) 224-SEMI or SDAPS at <https://sdaps.sd.gov/sdaps>. The ports are required because the bridge office only analyzes the overloads on the bridge superstructure, but the Port of Entry issues permits, determines fees, and reviews all information (bridge weight formula, maximum axle weights, width, height, etc.).
- **Multi-trip permits** – Are valid for all non-interstate bridges on state routes in a county or counties and must be issued annually. The email with the overload normally lists the counties included in the permit. Select "Tools" on the trip page and load rate the bridges for the counties requested.

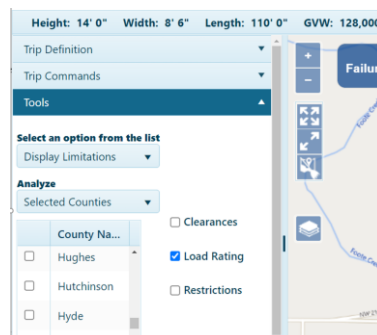

- **Legal-load Calculator** available on the [Admin](#) tab after signing in at <https://sdaps.sd.gov/sdaps/permits/Application/30000#!>
- If a permit disappears from the queue in SDAPS and hasn't been recalled, you may need to request that the permitting staff "clear in use permits". Logging out of SDAPS instead of closing the application should prevent permits from failing to display.

Appendix E: Overload Example 1

View the axle configuration, truck display, route, and failed bridges in SDAPS.

Axle Configuration	Truck Display							
	1	2	3	4	5	6	7	8
Weight:	13000	13000	13000	13000	17000	17000	17000	17000
Number of Tires:	2	4	4	4	4	4	4	4
Tire Width:	11	11	11	11	11	11	11	11
Axle Width:	8' 0"	8' 0"	8' 0"	8' 0"	8' 0"	8' 0"	8' 0"	8' 0"
Axle Spacing:	13' 6"	4' 6"	4' 6"	4' 6"	4' 6"	4' 6"	14' 0"	

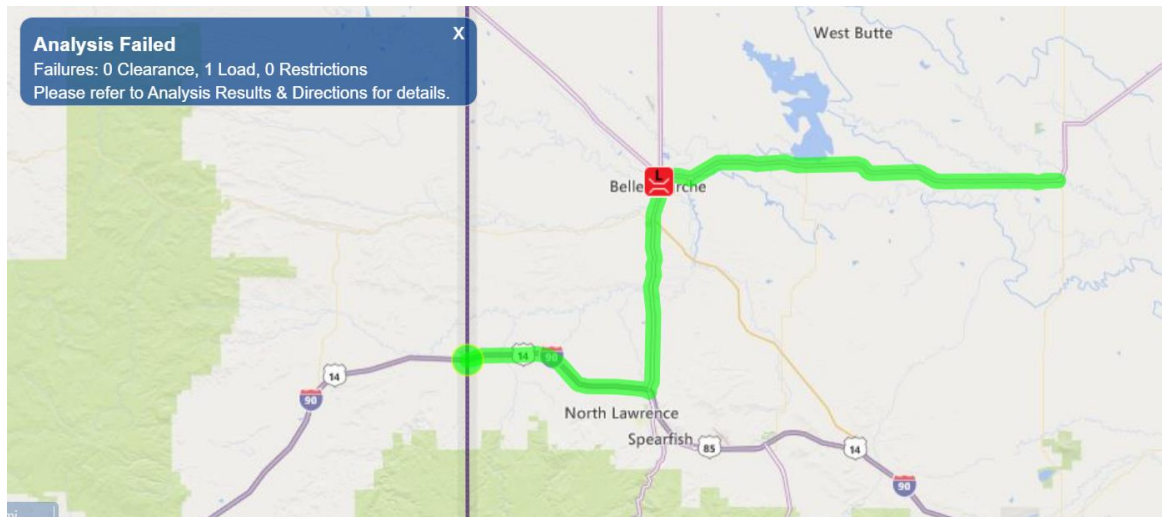
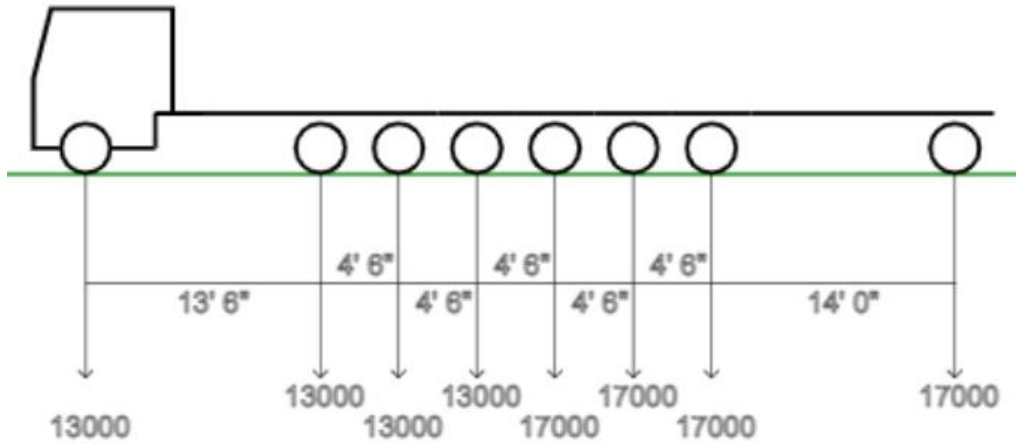

Structure ID	Status	MULTIPLE TRUCK LOADING						SINGLE TRUCK LOADING			
		W/ IMPACT		LOW IMPACT		W/O IMPACT		W/ IMPACT		LOW IMPACT	
		RATING FACTOR	SAFE LOAD (TONS)	RATING FACTOR	SAFE LOAD (TONS)	RATING FACTOR	SAFE LOAD (TONS)	RATING FACTOR	SAFE LOAD (TONS)	RATING FACTOR	SAFE LOAD (TONS)
10098371	Fail	0.73	43.61	0.79	47.12	0.86	51.83	0.92	55.50	0.99	59.97

Create a standard gage truck for the overload. Since no axle widths are greater than 8 feet, no axle weight reduction is possible.

Name:

Description:

Truck **Tandem** Lane

Axle no.	Axle load (kip)	Gage dist. (ft)	Wheel contact width (in)	Axle spacing (ft)	
				Minimum	Maximum
1	13.00	6.00			
2	13.00	6.00		13.50	13.50
3	13.00	6.00		4.50	4.50
4	13.00	6.00		4.50	4.50
5	17.00	6.00		4.50	4.50
6	17.00	6.00		4.50	4.50
7	17.00	6.00		4.50	4.50
8	17.00	6.00		14.00	14.00

Totals:

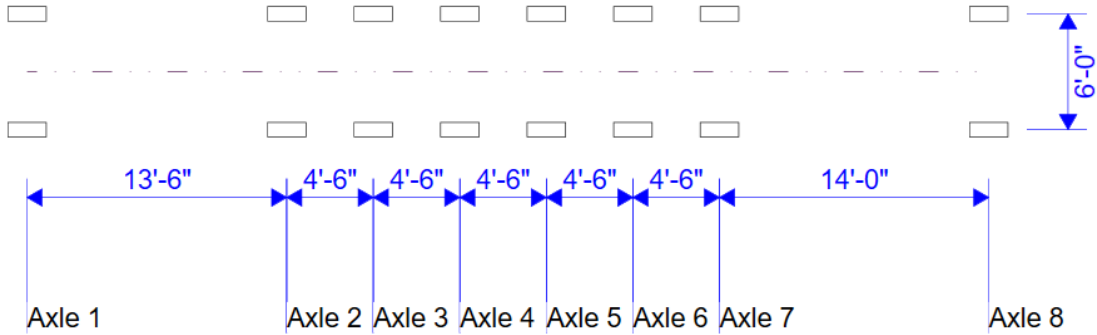

Rate the overload for the bridge using the options shown below.

Design review Rating

Rating method:

Save analysis results

Analysis type:

Lane / Impact loading type:

Apply preference setting:

Vehicles **Output** Engine Description

Traffic direction:

Refresh Temporary vehicles Advanced

Vehicle selection

- KS - MHET
- Landstar Ranger
- Lyons - SG Truck
- Miller Construction
- Miller Rotator Wrecker
- Mullen Trucking 2000-10-17
- New - Test
- Nick
- Nick #2
- Notional Rating Load
- Overload**

Add to >>

Vehicle summary

- Rating vehicles
 - Inventory
 - Operating
 - Overload**
 - Legal operating
 - Permit inventory
 - Permit operating

Review the rating results.

System of units: US customary SI / metric

Lane/impact loading type: As requested Detailed

Display format: Single rating level per row

Bridge ID	Vehicle	Rating level	Rating factor	Rating method	Capacity (Ton)	Time stamp
10098371	Overload	Operating	0.739	LFD	44.321	Tuesday, June 15, 2021 5:23:38 PM

System of units: US customary SI / metric

Lane/impact loading type: As requested Detailed

Display format: Single rating level per row

Bridge ID	Vehicle	Rating level	Rating factor	Rating method	Capacity (Ton)	Time stamp	Rated by	Impact	Lane
10098371	Overload	Operating	0.878	LFD	52.683	Tuesday, June 15, 2021...	virtis	Without Impact	Multi-Lane
10098371	Overload	Operating	1.118	LFD	67.051	Tuesday, June 15, 2021...	virtis	Without Impact	Single Lane
10098371	Overload	Operating	0.739	LFD	44.321	Tuesday, June 15, 2021...	virtis	With Impact	Multi-Lane
10098371	Overload	Operating	0.940	LFD	56.408	Tuesday, June 15, 2021...	virtis	With Impact	Single Lane

Look at the impact used in BrR for the controlling member.

% Impact Pos Reaction	% Impact Neg Reaction
22.216	22.216
22.216	22.216

Standard impact factor

For structural components where impact is to be included per AASHTO 3.8.1, choose the impact factor to be used:

$$I = \frac{50}{L + 125}$$

Standard AASHTO impact: $I = \frac{50}{L + 125}$

Live Load	Live Load Type	Rating Method	Rating Level	Load Rating (Ton)	Rating Factor	Location (ft)	Location Span-(%)	Limit State	Impact	Lane
Overload	Axle Load	LFD	Operating	52.68	0.878	170.06	2 - (50.0)	Design Flexure - Steel	Without Impact	Multi-Lane
Overload	Axle Load	LFD	Operating	67.05	1.118	170.06	2 - (50.0)	Design Flexure - Steel	Without Impact	Single Lane
Overload	Axle Load	LFD	Operating	44.32	0.739	170.06	2 - (50.0)	Design Flexure - Steel	With Impact	Multi-Lane
Overload	Axle Load	LFD	Operating	56.41	0.940	170.06	2 - (50.0)	Design Flexure - Steel	With Impact	Single Lane

In this case the multi-lane RF = 0.739 and the single lane RF = 0.940 (both with impact).

Calculate the single-lane low impact RF. There are several ways to do this.

- $0.739 * (7/5.5) * (0.99/.92) = 1.01$ or
Multi-lane RF DF ratio low/full impact ratio
- $0.940 * (0.99/.92) = 1.01$ or
Single lane RF low/full impact ratio
- $0.739 * (7/5.5) * (1.22216/1.1) = 1.04$
Multi-lane RF DF ratio full impact/10% impact ratio

The impact can change when using values from SDPAPS and BrR. When there are differences, it is advisable to use BrR rating factors and impact values together (or SDAPS rating factors and impact values together). In this case the controlling member is an interior girder in the second span of a 3 span continuous unit with spans 100.06', 140' and 100.06'. BrR uses 22.216% impact based on the 100.06' span and it appears SDAPS uses L = 140' in the equation resulting in 18.87% impact.

Since the rating factor ≥ 1 when running the load as a single vehicle and 10% impact, add a restriction for structure 10-098-371 on US85 at MRM 56.24 and approve the permit.

Appendix F: Overload Example 2

View the axle configuration, truck display, route, and failed bridges in SDAPS.

Axle Configuration	Truck Display				
	1	2	3	4	5
Weight:	11000	21500	21500	43000	43000
Number of Tires:	2	4	4	8	8
Tire Width:	385	11	11	255	255
Axle Width:	8' 0"	8' 0"	8' 0"	20' 0"	20' 0"
Axle Spacing:	15' 0"	4' 6"	45' 0"	4' 0"	

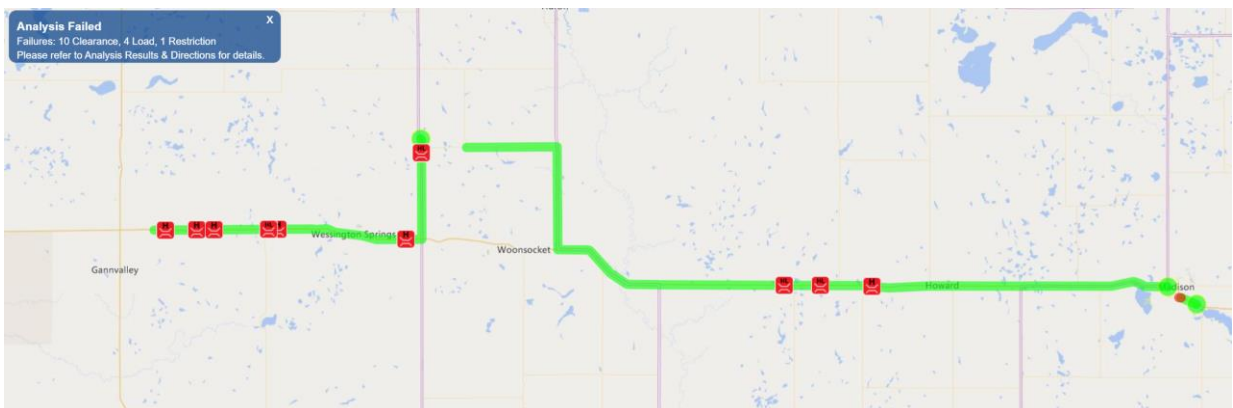
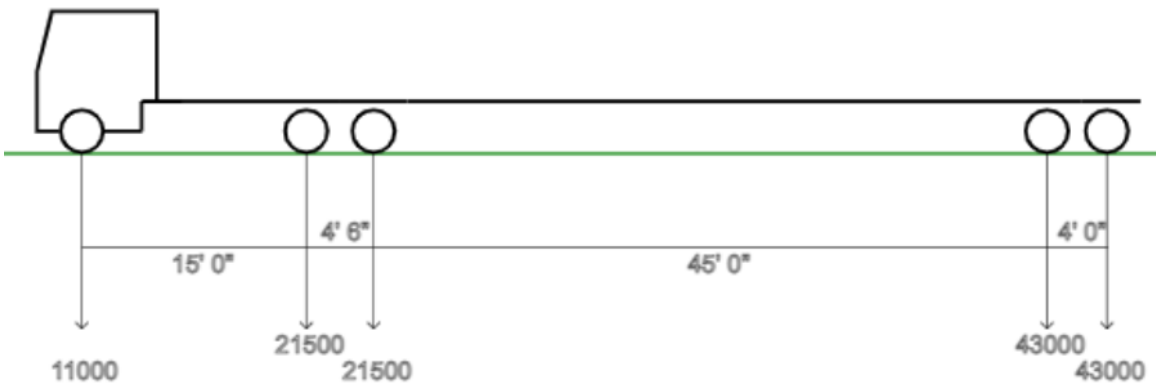

There are 4 bridges on the route with load failures in SDAPS.

Structure ID	Status	MULTIPLE TRUCK LOADING						SINGLE TRUCK LOADING			
		W/ IMPACT		LOW IMPACT		W/O IMPACT		W/ IMPACT		LOW IMPACT	
		RATING FACTOR	SAFE LOAD (TONS)	RATING FACTOR	SAFE LOAD (TONS)	RATING FACTOR	SAFE LOAD (TONS)	RATING FACTOR	SAFE LOAD (TONS)	RATING FACTOR	SAFE LOAD (TONS)
49053130	Fail	0.68	43.06	0.80	50.89	0.88	55.98	0.67	43.06	0.80	50.89
49021130	Fail	0.68	43.26	0.81	51.13	0.89	56.24	0.68	43.26	0.80	51.13
37239014	Fail	0.84	53.33	0.99	63.02	1.09	69.32	0.83	53.33	0.99	63.02
37102080	Fail	0.81	51.30	0.95	60.62	1.05	66.69	0.80	51.30	0.95	60.62

Since the 4th and 5th axles are at least 16 feet wide, divide these axle weights in half and use multilane loading to model the overload as two adjacent trucks. Remember to ignore ratings for single lane loading.

Reduced axle weight for axles 4 and 5 = $0.5 * (43 \text{ k}) = 21.5 \text{ k}$

Create a standard gage truck in BrR for the overload.

Name:

Description:

Truck		Tandem	Lane		
Axle no.	Axle load (kip)	Gage dist. (ft)	Wheel contact width (in)	Axle spacing (ft)	
				Minimum	Maximum
1	11.00	6.00			
2	21.50	6.00		15.00	15.00
3	21.50	6.00		4.50	4.50
4	21.50	6.00		45.00	45.00
5	21.50	6.00		4.00	4.00

Overload 2
Vehicle Plan
06/15/2021 6:37:15 PM

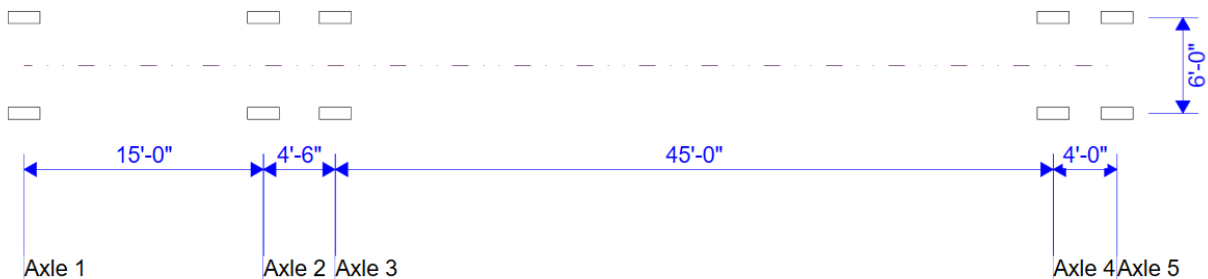

Rate the overload for the 4 bridges using the options shown below.

Design review Rating

Rating method:

Save analysis results

Analysis type:

Lane / Impact loading type:

Apply preference setting:

Traffic direction:

Vehicle selection

- Miller Rotator Wrecker
- Mullen Trucking 2000-10-17
- New - Test
- Nick
- Nick #2
- Notional Rating Load
- Overload 2
- Paver
- Perkins - #1

Add to

Vehicle summary

- Rating vehicles
 - Inventory
 - Operating
 - Overload 2
 - Legal operating
 - Permit inventory
 - Permit operating

Review the rating results.

System of units: US customary SI / metric

Lane/impact loading type: As requested Detailed

Display format:

Bridge ID	Vehicle	Rating level	Rating factor	Rating method	Capacity (Ton)	Time stamp
49053130	Overload 2	Operating	1.230	LFD	59.633	Tuesday, June 15, 2021...
49021130	Overload 2	Operating	1.164	LFD	56.448	Tuesday, June 15, 2021...
37239014	Overload 2	Operating	1.439	LFD	69.806	Tuesday, June 15, 2021...
37102080	Overload 2	Operating	1.469	LFD	71.234	Tuesday, June 15, 2021...

Since the operating ratings are greater than 1, approve the permit without adding any additional restrictions. All four of these bridges are slab bridges, so it doesn't matter, but with other bridge types make sure you use the multi-lane rating instead of single lane.

Options if some of these bridges rated less than 1.

- Lower impact to 10% and add a restriction
- For most girder bridges run non-standard gage analysis
 - reduce impact if needed.

REFERENCES:

1. AASHTO *Manual for Bridge Evaluation* (2018 edition with current interims)
2. FHWA. 2012. *Bridge Inspector's Reference Manual (BIRM)*, Federal Highway Administration, U.S. Department of Transportation, Washington, DC.
<https://www.fhwa.dot.gov/bridge/nbis/pubs/nhi12049.pdf>
3. AASHTO LRFD Bridge Design Specifications, 9th Edition (2020) including all subsequent interim revisions.
4. NCHRP Report 575, *Legal Truck Loads and AASHTO Legal Loads for Posting*.
https://www.fhwa.dot.gov/exit.cfm?link=http://onlinepubs.trb.org/onlinepubs/nchrp/nchrp_rpt_575.pdf
5. SD Truck Size & Weight Configurations. <https://sdtruckinfo.sd.gov/rules-regulations/size-weight-regulations/>
6. SDDOT *Bridge Design Manual*. <https://dot.sd.gov/inside-sddot/forms-publications/manuals>
7. FHWA- Bridge Formula Weights
https://ops.fhwa.dot.gov/freight/publications/brdg_frm_wgths/fhwahop19028.pdf
8. FHWA - FAST Act Truck Size and Weight Provisions.
https://ops.fhwa.dot.gov/freight/pol_plng_finance/policy/fastact/tswprovisions/
9. FHWA Memorandum - Load rating for the FAST Act's Emergency Vehicles.
<https://www.fhwa.dot.gov/bridge/loadrating/161103.cfm>
10. FHWA - Timeframe for Installing Load Posting Signs at Bridges.
<https://www.fhwa.dot.gov/bridge/nbis/190417.pdf>
11. *South Dakota Commercial & Agricultural Vehicle Handbook*.
<https://sdtruckinfo.sd.gov/rules-regulations/motor-carrier-handbook/>
12. FHWA *Questions and Answers - Load Rating of Specialized Hauling Vehicles*
https://www.fhwa.dot.gov/bridge/loadrating/shv_qa.pdf
13. FHWA *Questions and Answers - Load Rating for the FAST act's Emergency Vehicles Revision R01* https://www.fhwa.dot.gov/bridge/loadrating/fast1410_qa.pdf
14. *Timber Construction Manual*, latest edition, and *USDA Forest Service Timber Design Specifications*.
15. *Proposed Modifications to AASHTO Culvert Load Rating Specifications*.
<http://www.trb.org/Main/Blurbs/180076.aspx>

16. *Load Rating for the Fast Act Emergency Vehicles Ev-2 and Ev-3*
http://onlinepubs.trb.org/onlinepubs/nchrp/docs/NCHRP20-07Task410FinalReport_March2019.pdf
17. *National Bridge Inspection Standards 2004 and 2009*
<https://www.govinfo.gov/content/pkg/FR-2004-12-14/pdf/04-27355.pdf> Final rule
<https://www.govinfo.gov/content/pkg/FR-2009-12-24/pdf/E9-30469.pdf>
18. *National Bridge Inspection Standards 2022*
<https://www.fhwa.dot.gov/bridge/nbis2022.cfm>
19. *Manual for Refined Analysis in Bridge Design and Evaluation*
<https://www.fhwa.dot.gov/bridge/pubs/hif18046.pdf>
20. *SDDOT Bridge Inspection Field Manual*
<https://dot.sd.gov/media/documents/SouthDakotaBridgeInspectionFieldManualMarch2022.pdf>
21. *Load-carrying Capacity Considerations of Gusset Plates in Non-load-path-redundant Steel Truss Bridges - Technical Advisory T5140.29*
<https://www.fhwa.dot.gov/bridge/t514029.cfm>.
22. *FHWA Memorandum - Bridge Load Ratings for the National Bridge Inventory*
<https://www.fhwa.dot.gov/bridge/nbis/103006.cfm>